

Mamiya  
**645DF+**

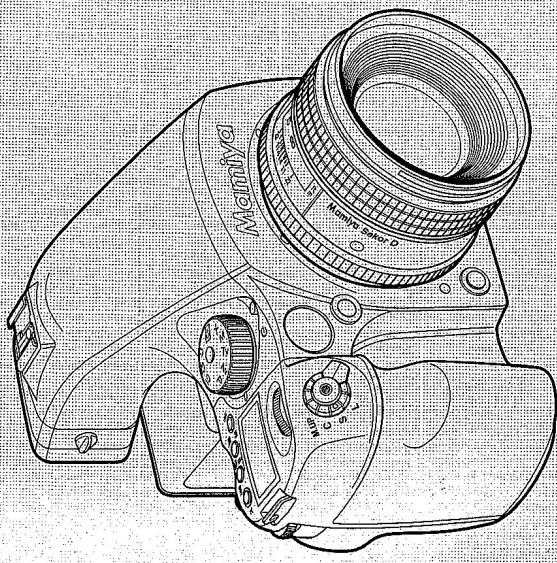

Instructions

## Congratulations on your purchase of the Mamiya 645DF Camera.

- 1** Mamiya pioneered the 645 SLR system camera three decades ago and the Mamiya 645DF, with its TTL auto-focus, auto-exposure and auto-flash is the latest Mamiya masterpiece and reflects its long tradition of medium format camera expertise.
- 2** Combining 35mm handling ease and speed but with an image size almost 3 times larger, it is a full-featured camera, utilizing many digital controls and LCD displays, and featuring 19 custom settings for fully personalized digital photography.
- 3** Its high-tech focal plane shutter with speeds up to 1/4000 sec. permits flash sync up to 1/125 sec. and has an exclusive "Safety Retraction" feature, which protects it against accidental damage.
- 4** The AE Prism Finder with its many features, protected by a sturdy magnesium housing, and also the Power Drive Grip, are now integral components of the die cast aluminum camera body, designed for heavy professional use.
- 5** All the many features, safety interlocks and other important information are covered in detail in these instructions. It is imperative that you read them thoroughly before you put your camera to work, in order to ensure proper operation and maximum results.

## Special Advice To Professional Photographers

Your Mamiya 645DF is designed for heavy professional use and will give you a long service life if properly maintained. Your camera and lenses have many moving parts which require periodic lubrication. Its electronic components, too, are subject to wear and tear and are affected by ambient conditions like dust, sand, sea air, heat and moisture.

If cameras had odometers like automobiles, it would be easier to specify servicing schedules. May we suggest that if you shoot thousands of images per year, you send your equipment annually for servicing to the Mamiya distributor in your country.

Mamiya 645DF corresponds with digital backs compatible with MSCE (Mamiya Serial Communication of External).

# Names of Parts and Functions

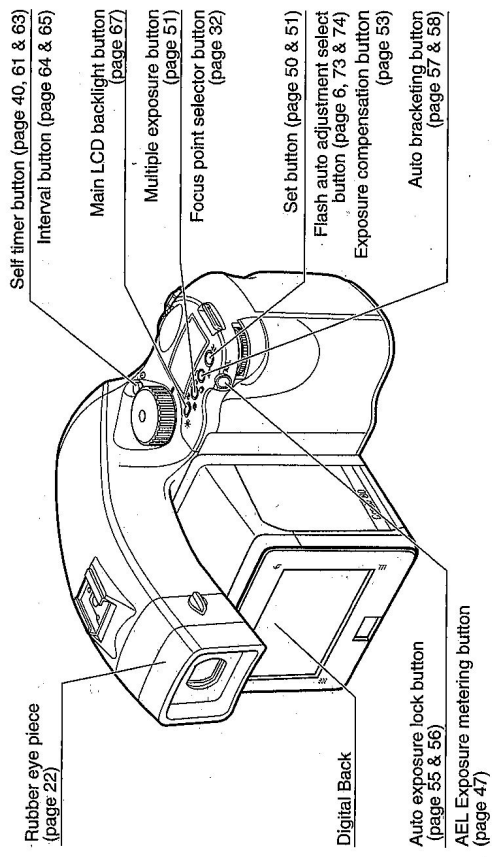
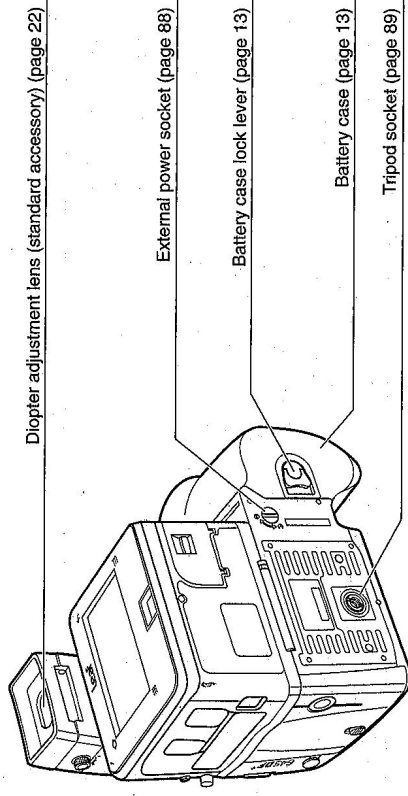
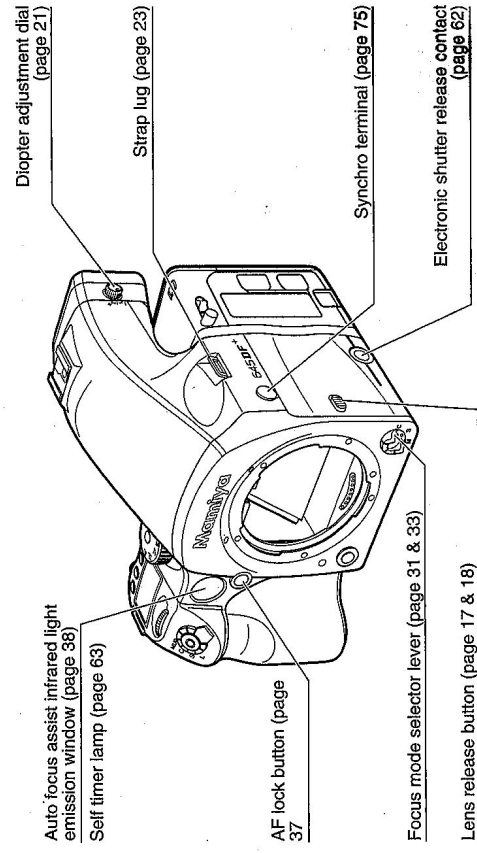
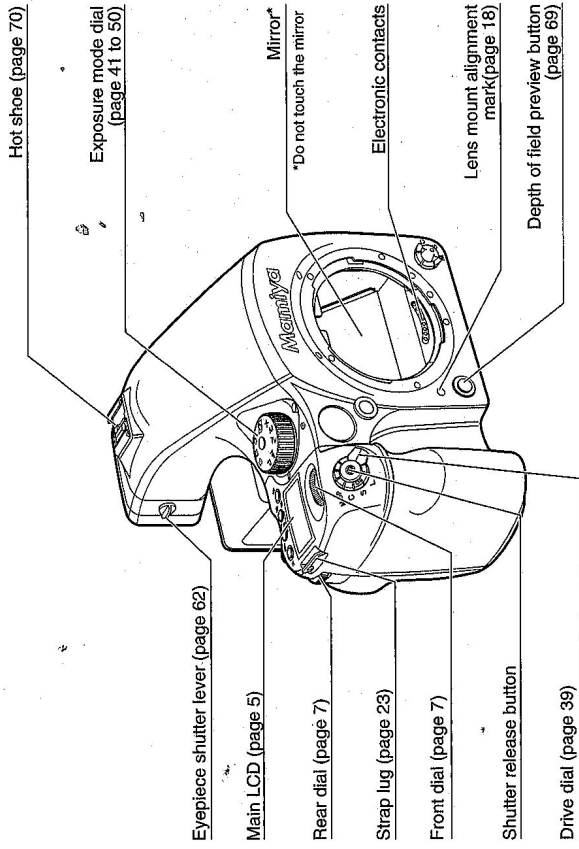

# Liquid Crystal Displays (LCD)

## Main LCD

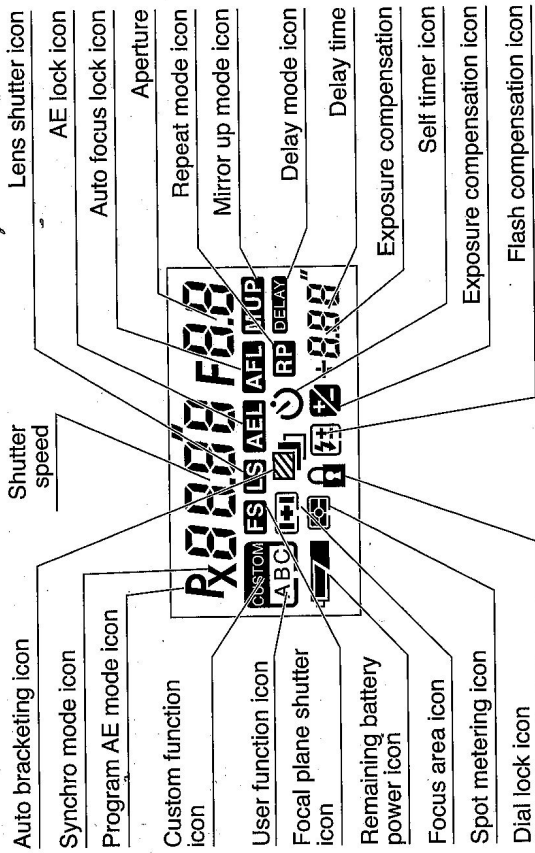

During actual use, only the relevant icons and indicators are displayed.

## Viewfinder LCD

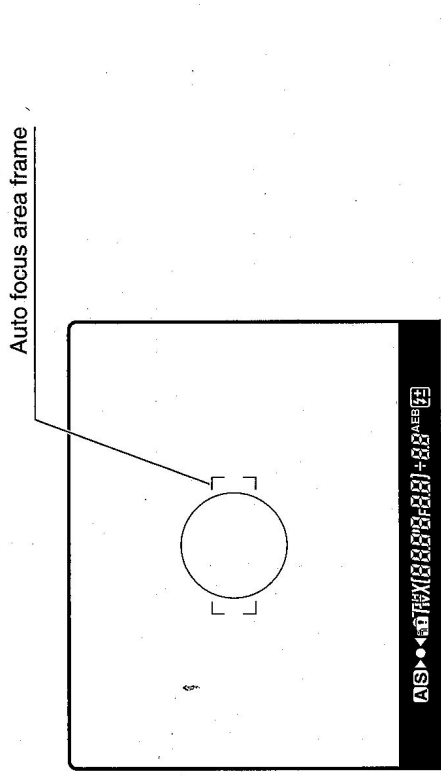

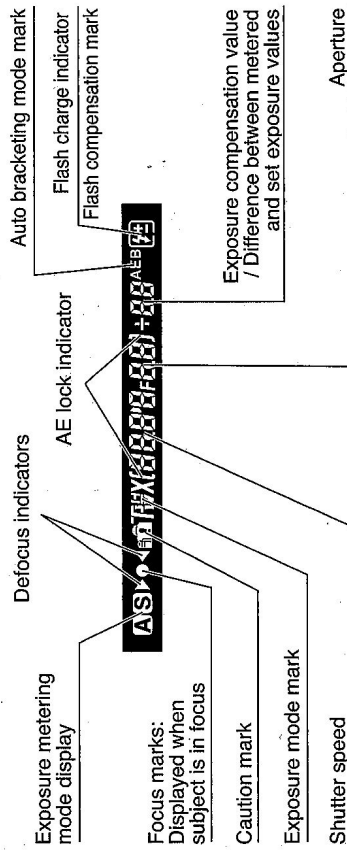

During actual use, only the relevant icons and indicators are displayed.



During actual use, only the relevant icons and indicators are displayed.

## Electronic Dial Operation

	Position	Front dial	Rear dial
Exposure mode	P	Program shift (P→P→P)	
	AV	Aperture adjustment	
	Tv	Shutter speed adjustment	
	M	Shutter speed adjustment	Aperture adjustment
	X	Aperture adjustment	Shutter speed adjustment 1/125 to 1/60
Auto-bracketing button	 displayed	Turn the auto bracket ON/OFF	The multi-turn auto bracketing repeat setting
Flash auto adjustment select button	 displayed	Flash metering compensation (when using Metz flash and SCA3952 adaptor)	

## Liquid Crystal Display

Due to the limitations of the space and letters, words and letters on the LCD are abbreviated.

Display examples of the main LCD

On → ON  
 Off → OFF  
 Err → Error  
 + → + (Plus)  
 U → Under  
 O → Over  
 n → Normal  
 L oc → Lock  
 SEL F → Self Timer  
 bul b → bulb  
 busy → Busy  
 db → Digital Back  
 L S → Lens Shutter  
 CAP → Capture  
 r p → Repeat  
 t i m e → Time

## Display examples in the custom function mode

SEL → Selection  
 STEP → Step  
 I r i s → Iris  
 H O l d → Hold  
 b a t t e r y → battery  
 S h o t N o . → Shot No.  
 d f → Dial function  
 d . R E → Dial action  
 d . d i → Dial direction  
 R E F L → AE, AF lock  
 H A L F P → Half press  
 R E L → AE lock  
 R F L → AF lock  
 O n E P → One-push exposure  
 A F L → AF assist light  
 F L S Y → Flash sync  
 b u z z e r → Buzzer  
 S h . P → Shutter in Program  
 S h → Shutter in Manual  
 R F \_ P → AF Priority  
 R F \_ F → AF Fine Tune

Preface ..... 1 to 2

Names of Parts and Functions ..... 3 to 4

Liquid Crystal Displays (LCD) ..... 5 to 6

Electronic Dial Operations ..... 7

Liquid Crystal Displays ..... 7 to 8

Before Taking Photographs ..... 12 to 23

Inserting the Batteries ..... 13

Checking the Battery Power ..... 14

Battery Power ..... 15

Battery Care ..... 16

Attaching and Removing a Lens ..... 17 to 18

Attaching and Detaching a Digital Back ..... 19 to 20

Dioptr Adjustment ..... 21

Replacing the Diopter Correction Lens ..... 22

Strap ..... 23

Basic Operation ..... 24 to 28

Attaching a Lens and Digital Back ..... 25

Taking Photos in the Fully Automatic Mode ..... 26 to 28

Advanced Photography and Various Functions ..... 30 to 75

Focus Modes ..... 31

Single focus mode(S) ..... 31

Continuous focus mode(C) ..... 31

Focus Area ..... 32

Normal focus area ..... 32

Spot focus area ..... 32

Selecting the focus area ..... 32

Manual Focus Mode ..... 33

Manual focus mode ..... 33

Lenses with the focus mode selector ..... 34

Attaching a Leaf Shutter Lens ..... 35

Manual focusing using the focus mark ..... 36

Using the Focus Lock Function ..... 37

AF Assist Infrared Light ..... 38

Drive Modes ..... 39 to 40

Single-Frame Mode ..... 39

Continuous Mode ..... 39

Mirror up Shooting ..... 39

Self Timer Mode ..... 40

Exposure Modes ..... 41 to 50

Program AE (P) ..... 41

Program Shift (P<sub>H</sub>/P<sub>L</sub>) ..... 41 to 42

Aperture Priority AE (Av) ..... 43

Shutter Priority AE (TV) ..... 44

Manual Mode (M) ..... 45 to 48

One-push shift function ..... 47

Auto mode mechanism ..... 48

Synchro mode (X) ..... 49

CF (Custom Function) Mode (CF) ..... 49

C1, C2 or C3 Modes ..... 50

Programming C1, C2 or C3 ..... 50

Exposure Metering Modes ..... 51

Average/spot auto exposure metering ..... 51

Center-weighted average/spot exposure metering ..... 51

Center spot exposure metering ..... 51

Exposure warnings ..... 52

Exposure Compensation ..... 53

AE Lock Mode ..... 55 to 56

Auto Bracketing Mode ..... 57 to 58

Taking Photos with the Mirror Up ..... 59 to 61

Electronic Shutter Release Contact ..... 62

Eyepiece Shutter ..... 62

Self Timer mode ..... 63

Interval Photography ..... 64 to 65

Long Exposure mode (Bulb Mode) ..... 66

Backlight button ..... 67

Front / Rear Dial Lock Function ..... 68

Depth of Field ..... 69

Depth of Field Preview ..... 69

Flash Photography ..... 70 to 72

Rear Curtain Sync Mode ..... 71

Metz Flash SCA3952 System Functions ..... 72

Flash Compensation Settings ..... 73 to 75

Custom Functions ..... 76 to 82

Setting Custom Functions ..... 77 to 78

Custom Functions of MAMIYA 645DF ..... 79

Types of Custom Settings ..... 80 to 82

Miscellaneous Operations ..... 84 to 98

Changing the Focusing Screen ..... 85 to 86

Using the M645 Manual Focus Lenses ..... 87

External Battery Socket ..... 88

Tripod ..... 89

When You Think Something Might Be "Faulty" ..... 90

When Any of These Displays Appear ..... 91 to 92

Specifications ..... 93 to 94

Common Sense Camera Care and Practice ..... 95

After-Sale Servicing ..... 96

# **Before Taking Photographs**

**Preparation before  
taking photographs**

Inserting a battery/Attaching and detaching a lens/Attaching  
and detaching a digital back/An explanation of settings.

## Inserting the Batteries (The camera will not operate without batteries)

Set the drive dial to "L" to turn off the power. Use six "AA" alkaline or lithium batteries.

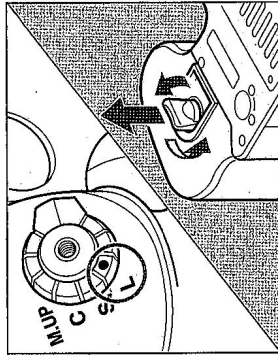

1. Lift the battery case lock lever, turn it counter clockwise and pull out the battery holder.

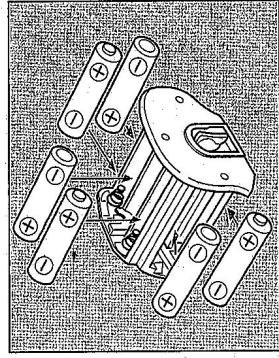

2. Install the batteries while ensuring their polarities are properly aligned with the ⊕ and ⊖ markings on the battery case.
  - Be sure the batteries are placed with proper polarity

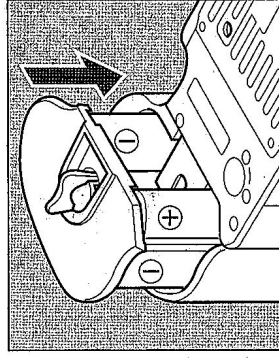

3. Return the battery holder to its case and lock it by turning the lever clockwise. Make sure it is fixed firmly in place.



Standard AA Alkaline batteries, Rechargeable nickel-metal hydride (Ni-MH), Nickel-cadmium (-cd) batteries, or Li-ion battery can be used. ➡ Custom settings (C-04 on page 80)

If the battery type and setting do not match, remaining battery power will not be displayed.

## Checking the Battery Power

Set the drive dial to "S" to turn on the power. Check the battery condition in the lower right corner of the main LCD.



The batteries are sufficiently charged.



There is little power remaining. Have new batteries on hand. Camera will still operate.

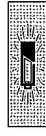

There is very little power remaining. Camera will stop operating soon.

Flashing

- ★ Set the shutter release mode selector lever to "L" (to turn the power off) and replace the batteries with new ones.



Flashing

- ★ When the batteries are spent, "batt" flashes on the main LCD and the viewfinder's LCD when the shutter release button is pressed.

★ When replacing the batteries, be sure to use six new batteries of the same type. Do not mix different types of batteries or old batteries with new ones.

Setting Battery Type [C-04]

1. Use the front dial to scroll to Custom function 04
2. Use the rear dial to select between 0, 1 and 2
  - 0 = Standard AA Alkaline batteries
  - 1 = AA NiMH / NiCD batteries
  - 2 = Li-ion Rechargeable battery



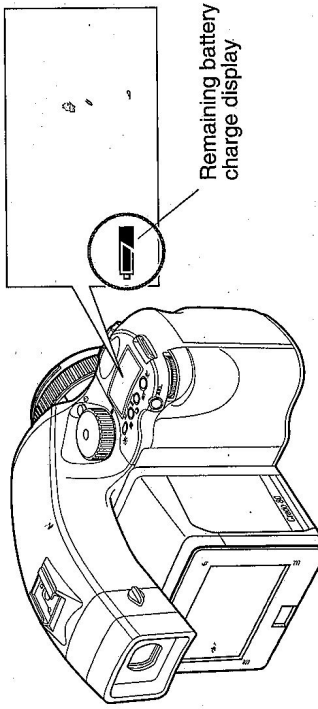

- The camera's power is turned on when the drive dial is set to "S," "C" or "M.U.P." In order to prevent the camera's battery power from draining, sleep mode is automatically established if no operations are performed for a specific period of time while the power is ON (with exposure metering status maintained).
- The initial setting for the exposure metering status maintenance period is 15 seconds. It can be changed at any time to a period within 30 sec., 60 sec. using the custom settings. (C-03 on page 84)
- In sleep mode, operating the shutter button or function setting button restores power ON status.
- In sleep mode, the shutter speed and f-number in the external LCDs go off, and the icon shown in the figure is displayed. (This mark appears in program AE mode.)

**For the purpose of the descriptions and explanations provided in these instructions, it is assumed that the camera's power is on.**

1. Battery life of the originally supplied batteries is dependant on storage conditions.
2. Blots and fingerprints on terminals may cause loose connection and corrosion. Wipe the terminals before loading the batteries.
3. It is advised to carry spare batteries in remote or foreign locations.
4. Battery performance decreases in low temperatures. Keep them warm when in cold climates or locations.  
External battery case PE401 is available as an optional accessory.
5. Store the batteries in a cool and dry place, away from direct sunlight.
6. Remove the batteries from the camera body when they will not be used for a long time.
7. Replace the batteries with new ones as soon as they are exhausted. Liquid leakage from the battery may damage the camera.
8. Read the label warnings of the batteries for their handling.

# Attaching and Removing a Lens

## Attaching

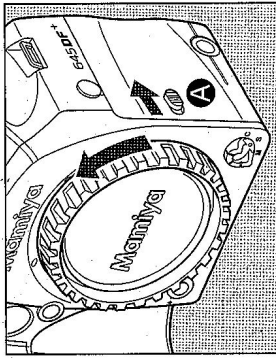

1. Remove the front body cap, just like you would remove a lens, by pushing the lens release button **A** backward and then turn the front body cap counter clockwise and lift out.

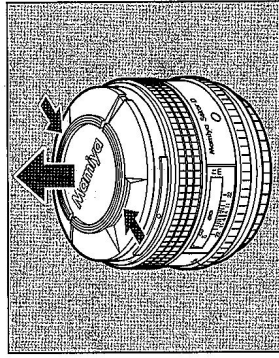

To remove the front lens cap, squeeze the shiny sections together and lift out.

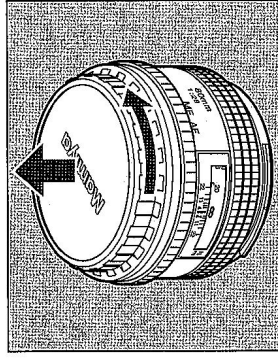

To remove rear lens cap turn it counter clockwise.

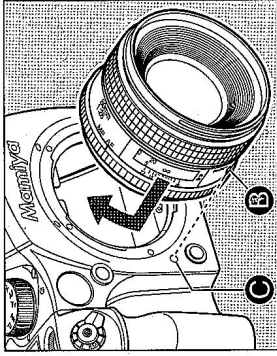

2. Attaching the lens  
Line up the lens mount alignment mark **B** with mark **C** on the camera to fit the lens in place, then rotate it in the direction of the arrow until it clicks into place.

- ★ Do not touch the distance ring or other rotating parts when attaching the lens.
- ★ When installing a lens, do not press the lens release button **A**.

## Removing

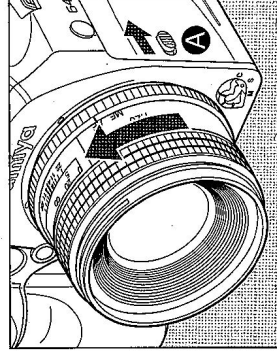

While sliding the lens release button back **A**, rotate the lens counter clockwise until it stops and lift it off.

- ★ After removing the lens from the camera body, protect both ends by attaching the caps.
- ★ Oil, dust, fingerprints or water on the electronic contacts could result in malfunction or corrosion. Wipe such impurities off with a clean piece of cloth.

# Attaching and Detaching a Digital Back

★ This manual explains the method for attaching and detaching CREDO digital back. For attaching and detaching backs from other makers, please refer to their instruction manuals.

## Before attachment

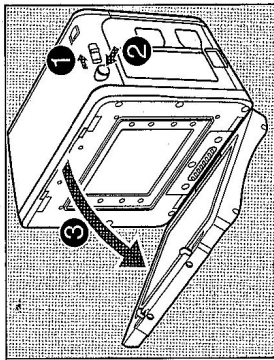

1. First remove the protective covers from the camera body and digital back. The CREDO digital back's removal lock release button on the left side of the body needs to be pressed in order to detach the protective cover.

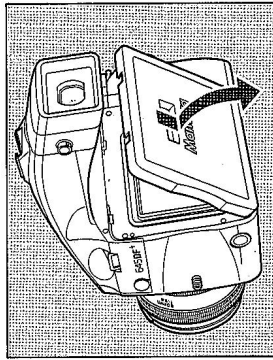

2. Remove the camera rear cap by putting a finger into the notch and sliding the cap down.

## Attachment

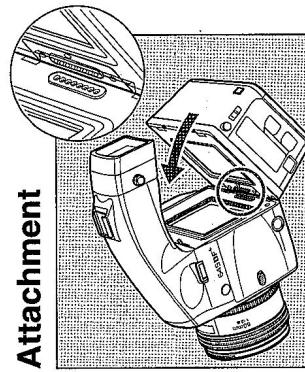

1. Align the lower contact pins of the digital back with the lower contact pins on the camera body.

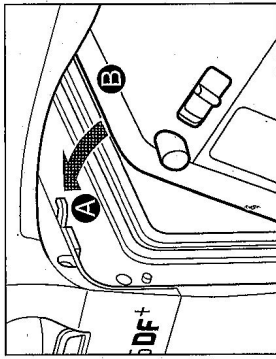

2. Rest the digital back on the lower ledge of the camera body so the camera body contact pins and digital back contact pins meet. Hold down the release button, then press the upper part of the digital back B to the camera body A. A click will be heard as the shutter is released, signaling that the back has been correctly mounted.

## Automatic setting of shutter

To protect the shutter curtain, when detaching the digital back from the camera the shutter curtain will automatically open and the mirror will go into the upright position, effectively locking the camera. When reattaching the digital back, the mirror and shutter will return to the set position and the camera becomes unlocked and ready for use.

★ When batteries are not inserted in the camera body, the shutter cannot be released.

## Detaching the digital back

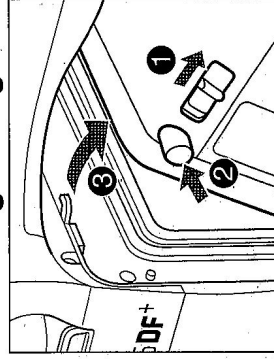

When detaching the digital back, press the release button and pull away from the camera body.

★ When detaching the digital back from the camera body, the shutter will automatically fire, the mirror will go to the upper position and the shutter curtain will open, leaving the camera locked.

## Diopter Adjustment

Look through the viewfinder and make sure that the focus frame (Rectangle with Circle) is in sharp focus. If it is not, turn the diopter adjustment dial in the "+" direction if you are nearsighted, in the "-" direction if you are farsighted. If this is not sufficient you may require an optional diopter correction lens. See below.

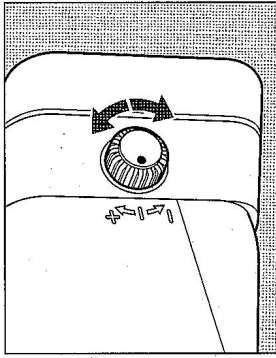

★ Point the camera at a bright, plain object such as a white wall when making this adjustment.

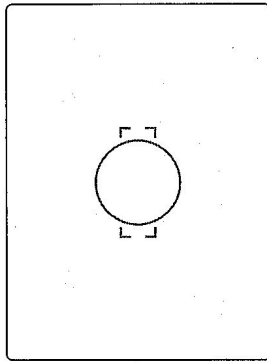

Diopter not matching.

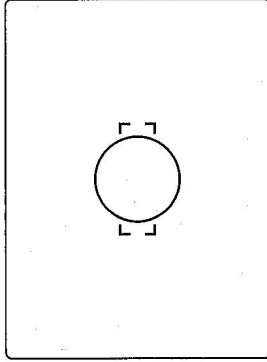

Diopter matching.

### Range of adjustment of diopter correction lenses (Optional accessory)

Diopter correction lens	Range of adjustment
DE401 (standard)	-2.5 to +0.5
DE402 (for nearsighted users)	-5.0 to -2.0
DE403 (for farsighted users)	0 to +3.0

## Replacing the Diopter Correction Lens

1. Hold down the release pin and remove the rubber eye piece by sliding upwards.

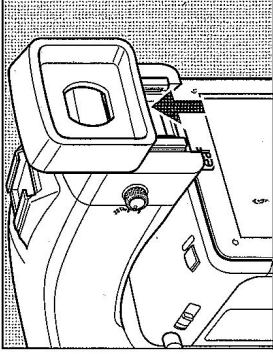

2. Remove the existing diopter by sliding downwards using the fingernail groove and detach.

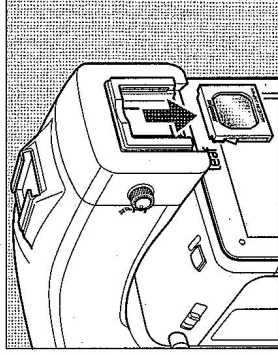

3. Insert a new diopter by aligning it to the base of the diopter holder and sliding it upwards into place then reattach the rubber eye piece.

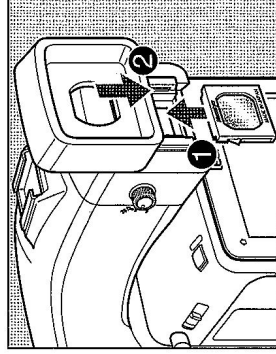

★ If there is dirt or dust on the lens surface, remove it with a blower or sweep it off gently with a lens brush.

★ If there are fingerprints or dirt on the lens surface, wipe away with a piece of clean, soft gauze.

★ Using solvents could discolor the diopter correction lens frame.

## Strap

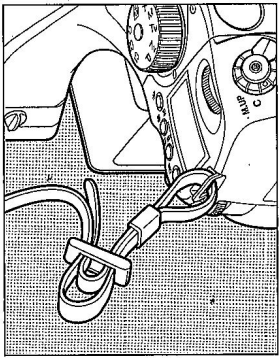

Put the neck strap through the mounts and secure it using the buckle as illustrated.

★ After attaching the strap, pull it and make sure it does not loosen at the buckle.



### Caution

- To ensure safety, pull the ends of the strap taut, and check that they are fastened securely to the metal mounts on the camera.

# Basic Operation

This section describes basic camera operations.

## Attaching a lens

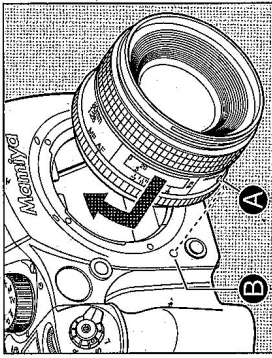

Line up the lens mount alignment mark **A** with mark **B** on the camera, to fit the lens in place, then rotate it in the direction of the arrow until it clicks into place.

## Attaching a digital back

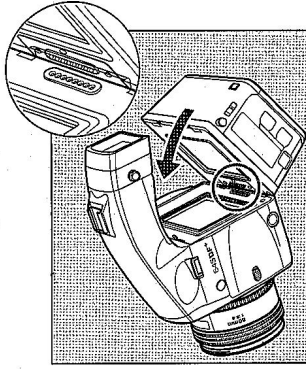

1. Align the lower contact pins of the digital back with the lower contact pins on the camera body.

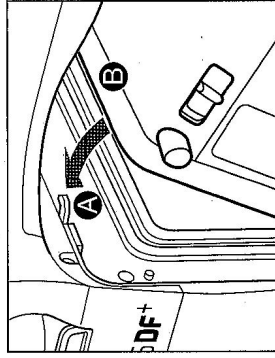

2. Rest the digital back on the lower ledge of the camera body so the camera body contact pins and digital back contact pins meet. Hold down the release button, then press the upper part of the digital back **B** to the camera body **A**. A click will be heard as the shutter is released, signaling that the back has been correctly mounted.

## 1. Set the drive dial to "S" (single-frame advance mode).

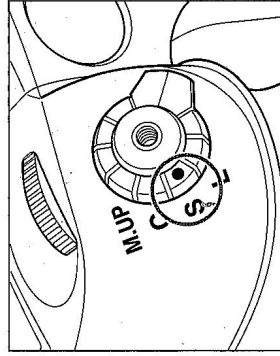

The drive dial has an "S" (single-frame advance mode) setting and a "C" (continuous advance mode) setting. (See page 42.)  
When set to "L," the power is turned off.  
When set to "M.U.P.," the mirror moves into the set position.

## 2. Set the focus mode selector lever to "S" (single focus mode).

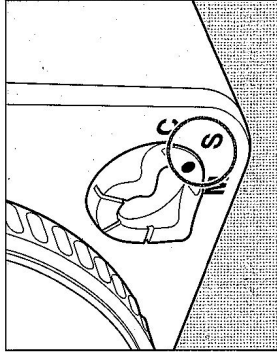

There are three focus modes: "S" (single focus mode), "C" (continuous focus mode) and "M" (manual focus mode).

Focus mode	Focusing
S	Half-press the shutter release button to focus. When the focus mark lights, the focus is fixed and the shutter can be released. (See page 33.)
C	The camera keeps focusing continuously while the shutter release button is half-pressed. The shutter can be released regardless of whether or not the focus mark is lit. (See page 33.)
M	Focus manually. (See page 35.)

### 3. Set the exposure mode selector dial to "P" (program auto exposure).

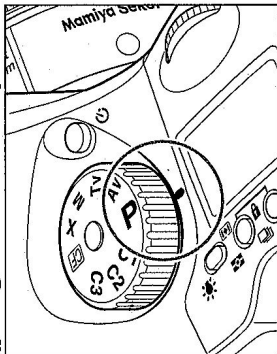

There are four exposure modes: "P" (program AE), "Av" (aperture priority AE), "Tv" (shutter priority AE) and "M" (manual mode). "X" is for synchro mode, while "CF" is used to for custom functions.

Exposure mode	Features
P	Program AE The aperture and shutter speed are determined automatically according to the shooting conditions. This mode is best suited for general photography, since it allows you to concentrate on the shooting. You can change the shutter speed and aperture by turning the front and rear dials while the "P" (Program AE) mode is selected. (See page 44 and 45.)
Av	Aperture priority AE Set the desired aperture and the camera selects the correct shutter speed. Use this mode to control depth of field. (See page 46.)
Tv	Shutter priority AE Set the desired shutter speed and the camera selects the correct aperture. Use this mode to stop motion. (See page 47.)
M	Manual mode Set this mode when you want to use special combinations of the aperture and shutter speed. (See page 48 to 51.)

### 4. Exposure metering mode is automatically set to average/spot exposure metering before exposure metering is performed.

There are three exposure metering modes: In the "A" mode the average brightness in the entire frame is measured with emphasis on the center of the frame. The brightness at a specific spot in the center of the frame is metered in the "S" mode. The "A-S" mode automatically switches between these two modes depending on the contrasts in the picture. (See page 51.)

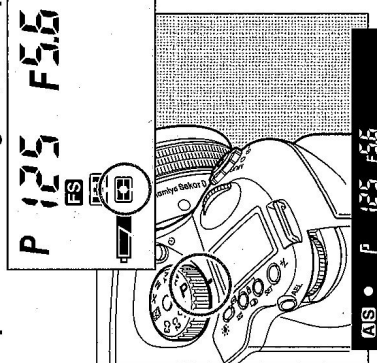

### 5. Focus

1. Aim the camera so that the subject is within the focus frame [ 1 ].

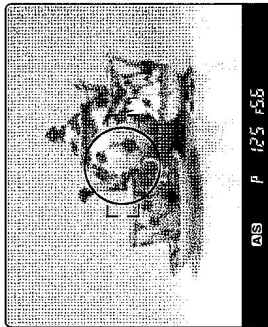

2. Half-press the shutter release button, and focus will be adjusted automatically.

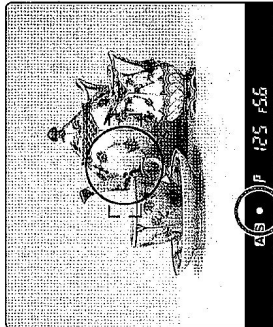

When the focus mark ● lights, the picture is in focus.

3. When ● lights, press the shutter release button further down to release the shutter.

#### Out of focus Marks

▶ ◀ Flashing: The picture is not focused and the shutter cannot be released.

Either press the shutter release button again to adjust the focus or move the camera to change the position of the focus frame.



# Advanced Photography and Various Functions

This chapter describes various  
functions of the camera.



## Single focus mode (S)

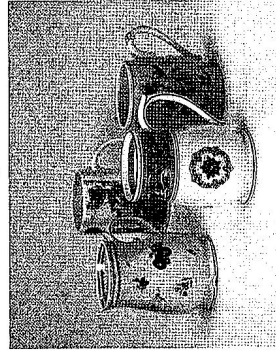

This mode uses the focus-priority mechanism. The shutter can be released when the focus mark ● in the viewfinder is lit. This mode is suited for still subjects. Focus is locked when the ● focus mark lights in the viewfinder's LCD.

★ The shutter cannot be released if the subject is not in focus (if the ● focus mark does not light).

★ To take another photo with a different composition, take your finger off the shutter release button then press the shutter release button again.

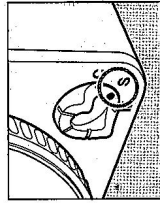

## Continuous focus mode (C)

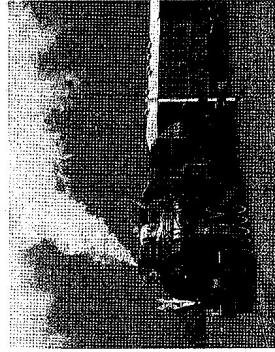

In this mode shutter release has priority to focusing. The shutter can be released regardless of whether the ● focus mark in the viewfinder's LCD is lit. Focus is adjusted continuously while the shutter release button is half-pressed. This mode is suited for moving subjects.

★ Focus is not locked even if the ● focus mark is lit.

★ The shutter can be released even if the ● focus mark is not lit.

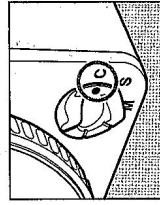

## Focus Area

With this camera, you can select the focus area that best suits the kind of pictures you intend to take. The selected focus area can be checked on the external LCD panel.

### Inside the View-finder

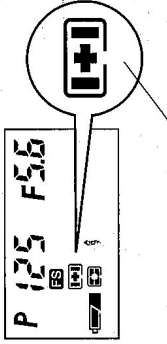
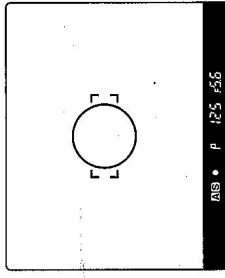

Focus point selection mark

### Normal focus area

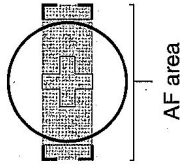

### Spot focus area

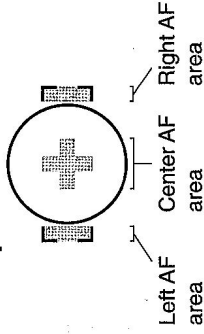

Bring the subject into focus inside the focus frame ○ mark on the viewfinder.

Select the frame from among the ○, □, and ⊕ focus frame marks on the viewfinder, and bring the subject into focus.

## Selecting the focus area

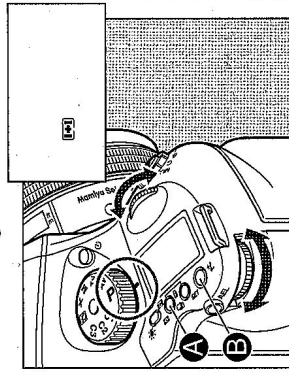

1. When focus point selector button **A** is pressed for 1 second, the focus point selection mark appears on the display.
2. Turn the front or rear dial, and select automatic selection (□), left (□), center (□) or right (□).
3. Press the SET **B** or focus point selector button **A** to enter the setting.

## Manual focus mode (M)

The auto focus function can be cancelled, and you can focus manually.

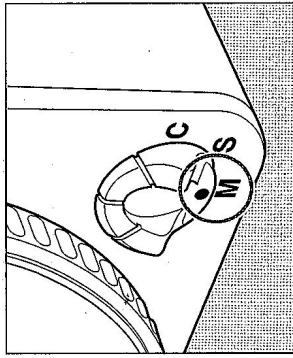

### 1. Switch to "M" (manual focus mode).

Turn the focus mode selector lever and set it to "M" (manual focus mode). **(M.F)** appears on the external LCD panel.

### 2. Manual focus operation for telephoto and zoom lenses.

All Mamiya 645 AF Telephoto and Zoom lenses can be switched from Auto Focus to Manual Focus by sliding the focusing ring on the lens FORWARD until it clicks. When this is done, the "Auto Focus" inscription on the lens barrel is covered and the lens can then be focused manually. When the FOCUSING RING is set in this position the external LCD display on the top of the camera will show **(M.F)**. It is not necessary to set the FOCUS MODE SELECTOR on the body to "M". To switch back to auto focus, simply slide the focusing ring BACK towards the camera and the "Auto Focus" inscription on top of the lens will again be visible.

This method applies to Mamiya 645 AF Telephoto and Zoom lenses only.

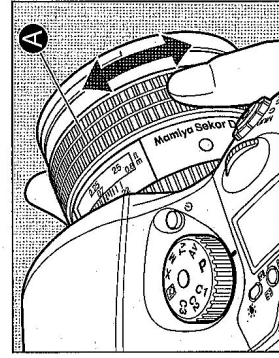

### 3. Adjust the focus.

Turn the lens focusing ring **A** until the subject is in focus. When it is in focus, the **(●)** focus mark lights in the viewfinder LCD. (See page 36.)

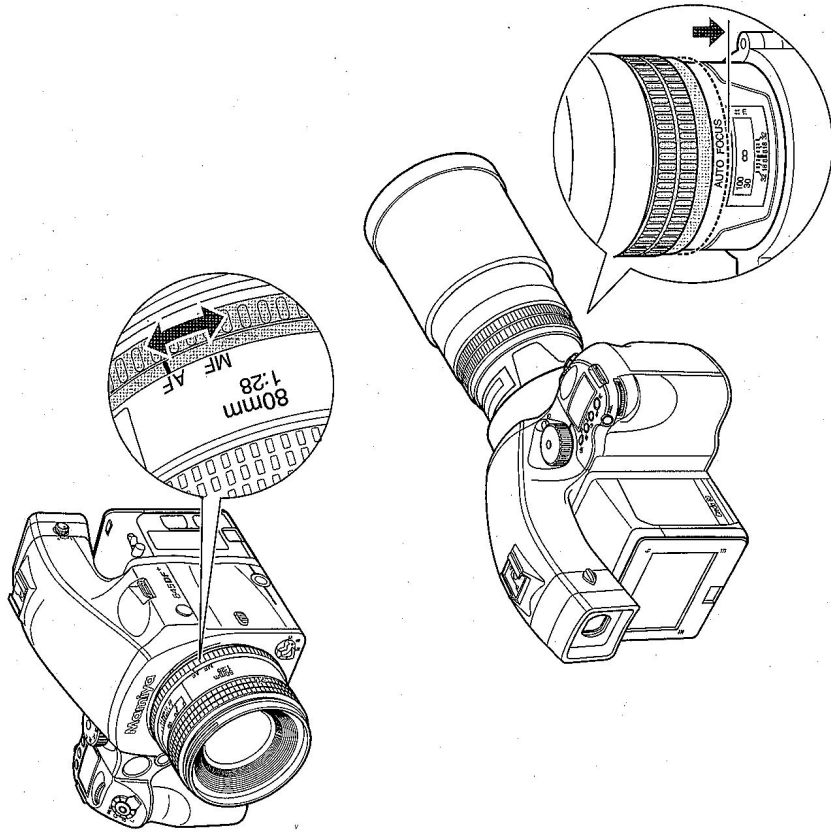

★ When a lens with the focus mode selector is attached and the focus mode selector lever of the camera body is set at "S" or "C", you can change focus modes between automatic and manual with the selector of the lens.

★ To use the auto focus function, both the camera body and the lens have to be set in the auto focus mode.

★ When either the camera body or the lens is set in the manual focus mode, auto focus does not function.

★ See the instruction manual for each lens for the way to switch focus modes on the lens.

## Attaching a Leaf Shutter Lens

Leaf shutter lenses are equipped with an internal shutter. When set on X, leaf shutter lenses charge quickly and are capable of high shutter speeds (1/800 sec.) with flash synchronization during daytime shooting. By merely pressing the shutter button, the leaf shutter will automatically charge, allowing for rapid photography.

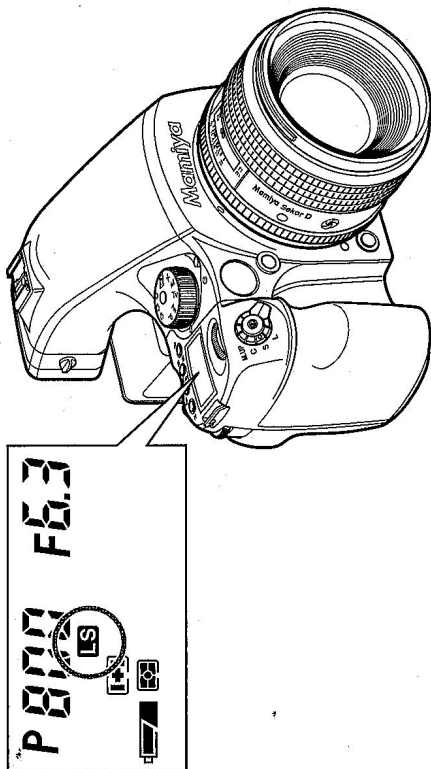

When the leaf shutter lens is attached, the letters "LS" will appear in the main LCD display. (The leaf shutter icon will also appear).

MEMO  
When using settings "P" (Program AE), "Av" (Aperture priority AE) or "Tv" (shutter priority AE), it is possible to change to focal plane shutter photography.

➔ Custom settings (C-17 on page 81)

## Manual Focus Mode (continued)

### Manual focusing using the focus mark

(Focus confirmation method)

With this camera, the focus mark ● lights in the viewfinder's LCD when the picture is in focus. With the shutter release button half-pressed, turn the lens focusing ring to focus on the subject. When the subject is in focus, the ● focus mark lights in the viewfinder's LCD.

If ► is lit in the viewfinder's LCD, the camera is focused on a point behind the object.  
If ◀ is lit, the camera is focused on a point in front of the object.

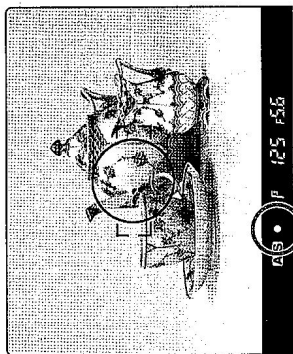

In focus



Turn the focusing ring clockwise.



Turn the focusing ring counterclockwise.

★ Use the focus mark when taking photos in manual focus mode or using the M645 manual lens.

★ If you adjust focus using the focus mark with an M645 lens, make sure to open the aperture. You can use this function with a lens of f/5.6 aperture or higher.

If the object that you want to focus on is not in the focus frame , the camera focuses on the background at the center. In such cases use the focus lock function to lock the focus before releasing the shutter.

### 1. Set the focus mode selector lever to "S" or "C."

Put the subject in the focus frame  and half-press the shutter release button.

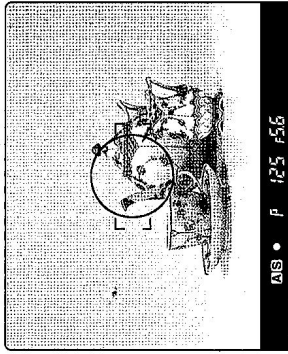

### 2. Lock the focus.

When the  focus mark in the viewfinder LCD is lit, press the AF lock button on the front of the camera to lock the focus.

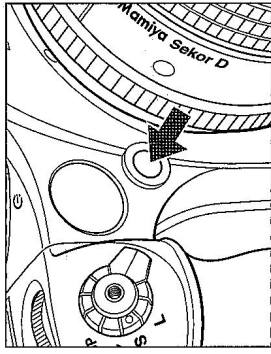

### 3. Adjust the composition.

With the shutter release button half-pressed, slide the camera to achieve the desired composition, and release the shutter.

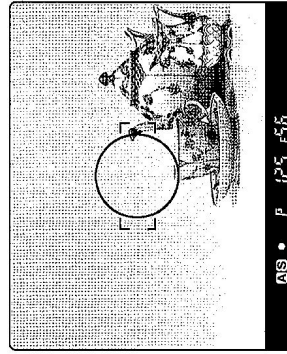

- 1. Assignment of the AEL and AFL buttons can be swapped.
  - ➔ Custom settings (C-09 on page 81).
- 2. You can set the camera so that when the AFL button is pressed, AF is activated and AF lock is performed
  - ➔ Custom settings (C-12 on page 81)



When the subject is dark or under-exposed and the camera fails to auto-focus, a red lamp may light on the front of the camera when the shutter release button is half-pressed. This is a light that assists the camera's auto focus function.

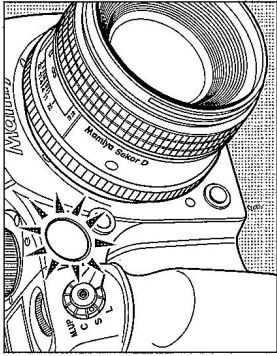

- ★ The AF assist infrared light is emitted only when the focus mode is set to "S" (single focus mode).
- ★ Effective range of the AF assist infrared light is limited. It does not reach distant subjects.
  - Range: 9m/29.5 ft. (using 80 mm f/2.8 lens under our test conditions)
- ★ When using a lens hood or a bellows lens hood (sold as an optional accessory) that may interfere with the assist light, set focus before mounting the hood.

The AF assist infrared light can be disabled.  
 ➔ Custom settings (C-14 on page 81)



**Single-Frame Mode**

The film is advanced by one frame each time the shutter is released.

Set the shutter release mode selector lever to "S".

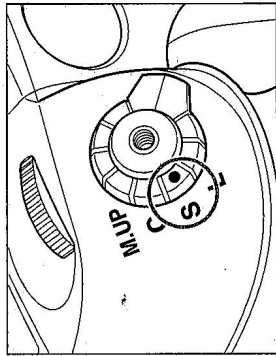

**Continuous Mode**

Photographs are taken continuously as long as the shutter release button is pressed.

Set the shutter release mode selector lever to "C" and hold down the shutter for continuous shooting.

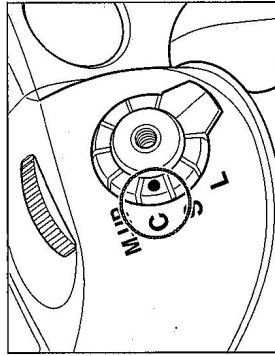

**Mirror up Shooting**

When the shutter button is pressed, the mirror moves up, and when the shutter button is pressed again, the shutter is tripped, and a picture is taken. For the mirror up shooting procedure, see pages 59 to 61.

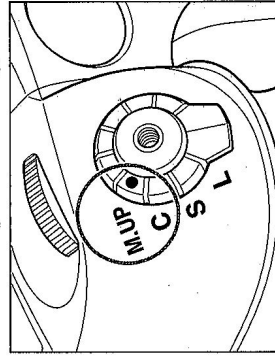

**Self Timer Mode (⊙)**

In this mode, the shutter will be released after the set time once the shutter button has been pressed.

For instructions about the self timer function, see page 66.

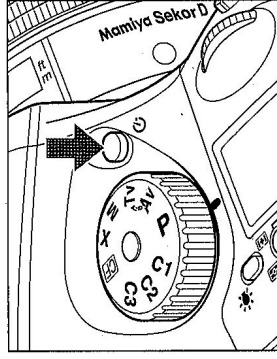

## Exposure Modes

### Program AE (P)

The aperture and shutter speed are determined automatically for the optimum exposure, according to the existing ambient light. This mode is best suited for general photography, allowing the user freedom to concentrate on the subject.

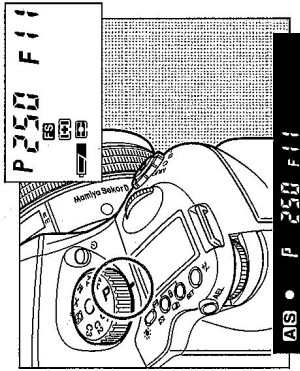

Turn the exposure mode setting dial to "P" (program AE) position.

★ If a correct exposure cannot be obtained, the shutter speed and aperture value blink. In such cases, the pictures can be taken but they may turn out too bright or too dark.

### Program Shift (P<sub>H</sub>/P<sub>L</sub>)

You can change the shutter speed and aperture by turning the front dial in the "P" (Program AE) mode. In order to avoid blurred images (shake while releasing the shutter), or to open the aperture, change to "P<sub>H</sub>" (high speed). For slower shutter speeds and wider depth of field, change to "P<sub>L</sub>" (low speed). This function allows you to make these changes quickly.

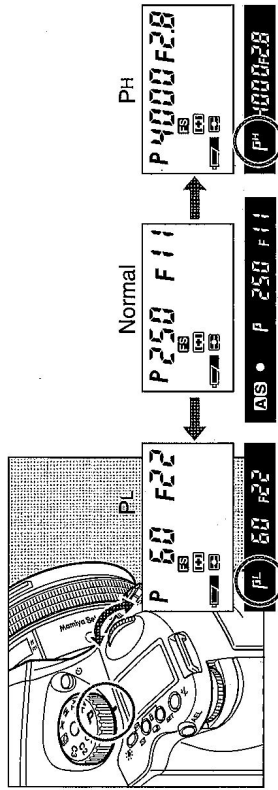

645DF program shift chart

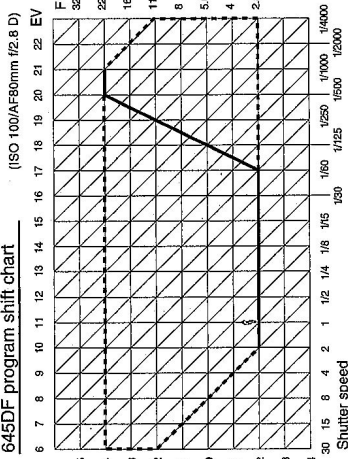

★ When the Program line is shifted, the aperture value changes along with the shutter speed to maintain the proper exposure.



1. Increment of the aperture and shutter speed can be set at either 1/3 or 1/2-stop.  
 → Custom settings (C-01 on page 80)
2. Even if the leaf shutter lens is attached, the camera can be programmed to use the focal plane shutter.  
 → Custom settings (C-17 on page 81)

## Exposure Modes (continued)

### Aperture Priority AE (Av)

Set the desired aperture, and the camera selects the optimum shutter speed accordingly. Use the Av mode to maintain specific control over depth of field, i.e. taking portraits or landscapes.

1. Turn the exposure mode setting dial to "Av" (aperture priority AE) position.

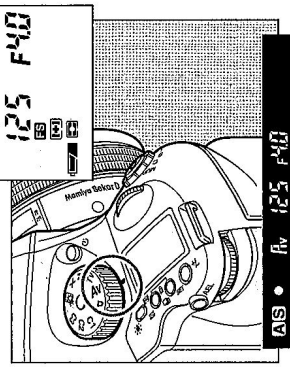

2. Turn the front or rear dial to set the desired aperture.

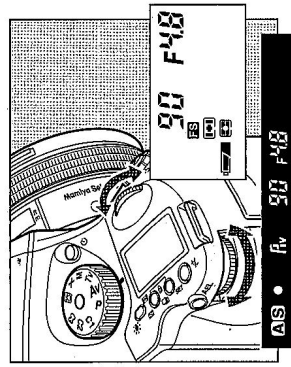

★ The shutter speed value will blink when the subject is too dark or too bright for a correct exposure. To obtain the correct aperture, adjust the aperture value until the shutter speed value stops blinking and remains lit.

- MEMO
1. Increment of the aperture can be set to your preference.  
→ Custom settings (C-01 on page 80)
  2. Rotation direction of the dials to change the values can be altered.  
→ Custom settings (C-08 on page 80)
  3. The selected aperture level can be locked. → Page 68
  4. Even if the leaf shutter lens is attached, the camera can be programmed to use the focal plane shutter.  
→ Custom settings (C-17 on page 81)

### Shutter Priority AE (Tv)

Set the desired shutter speed and the camera selects the optimum aperture accordingly. Fast shutter speed can be used to freeze motion, and slow shutter speed can be used to blur motion on purpose.

1. Turn the exposure mode setting dial to "Tv" (shutter priority AE) position.

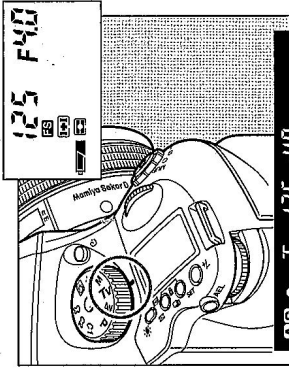

2. Turn the front or rear dial to set the desired shutter speed.

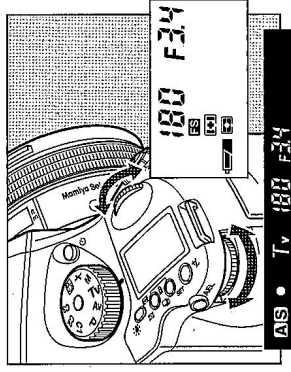

★ The aperture value will blink when the subject is too dark or too bright for a correct exposure. To obtain the correct aperture, adjust the shutter speed value until the aperture value stops blinking and remains lit.

- MEMO
1. Increment of the shutter speed can be set to your preference.  
→ Custom settings (C-01 on page 80)
  2. Rotation direction of the dials to change the values can be selected.  
→ Custom settings (C-08 on page 80)
  3. The selected shutter speed can be locked. → Page 68
  4. Even if the leaf shutter lens is attached, the camera can be programmed to use the focal plane shutter.  
→ Custom settings (C-17 on page 81)

## Exposure Modes (continued)

### Manual Mode (M)

This mode is used to set both the aperture and shutter speed for total exposure control.

Varying shutter speeds can be selected, including "bulb", "TIME" and manually from 60 mins to 1/4000 sec. Aperture values can be set from maximum to minimum aperture.

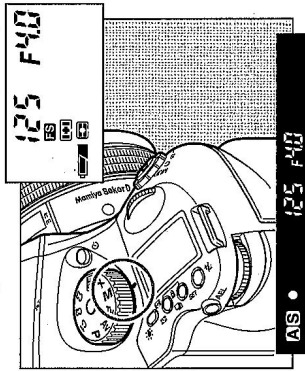

1. Turn the exposure mode setting dial to "M" (Manual) position.

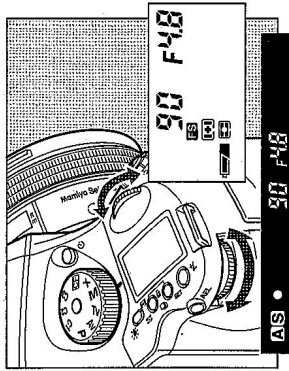

2. Turn the rear dial to set the desired aperture.
3. Turn the front dial to set the desired shutter speed.



1. The selected aperture and shutter speed can be locked. → Page 68
2. Increment of the aperture and shutter speed value can be set to your preference.  
→ Custom settings (C-01 on page 80)
3. The assignments of the front and rear dials can be swapped.  
→ Custom settings (C-06 on page 80)
4. Rotation direction of the dials to change the values can be selected.  
→ Custom settings (C-08 on page 80)

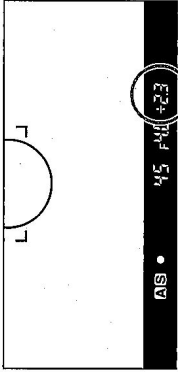

4. When the shutter release button is half-pressed, the difference between the present settings and the metered value is displayed in the viewfinder's LCD panel. The value is displayed in 1/3 stop increments within a range of  $\pm 6$  EV.

★ Example: "+2.3" indicates  $+2\frac{1}{3}$  EV, "-5.7" indicates  $-5\frac{2}{3}$  EV.

- ★ When the chosen setting and metering values are the same, the metering difference value will be displayed as "0.0" in the viewfinder.
- ★ When the exposure is compensated in the Manual mode, the difference between the metered value and the compensated value will be displayed in the viewfinder LCD. In the B (Bulb) mode, the difference with the metered value is not displayed.

### Displays when the difference in the exposure metering values exceeds $\pm 6$ EV



When the setting and metering value exceed each other, values under  $\pm 6$ EV will be displayed as "- U -" and values over  $\pm 6$ EV will be displayed as "- 0 -".



## Exposure Modes (continued)

### One-push shift function

Using choice "1" from custom settings (C-13, page 85), when the difference between the set value and metered value is displayed on the viewfinder LCD, press the AEL button for one second in "M" mode and the camera will automatically adjust the shutter speed to achieve the correct exposure based on the set aperture value.

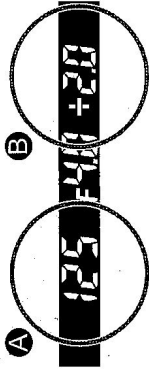
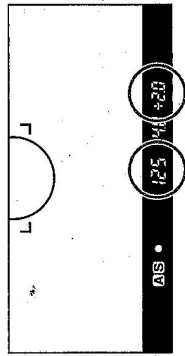

While the difference **B** between the set value **A** and the metered value is displayed on the viewfinder LCD, press the AEL button **C** for approximately one second. The camera changes the shutter speed to an appropriate level.

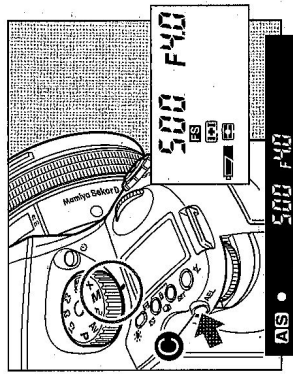

MEMO The aperture level can be selected for the parameter to shift.  
 ↑ Custom settings (C-13 on page 81)

### Auto mode mechanism

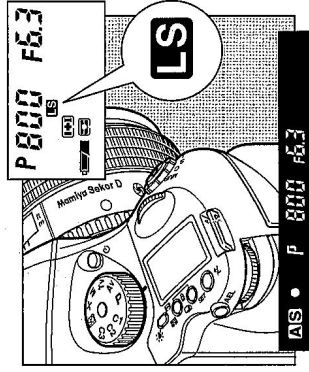

When using the leaf shutter lens, the leaf shutter's working range is from 1/800 sec. to 1 sec. For other speeds (1/4000-1/800 sec., 1-60sec., bulb) use the focal plane shutter.

MEMO Photography using the lens shutter or focal plane shutter can be selected in custom settings. (C-18 on page 81)

## Exposure Modes (continued)

### Synchro mode (X)

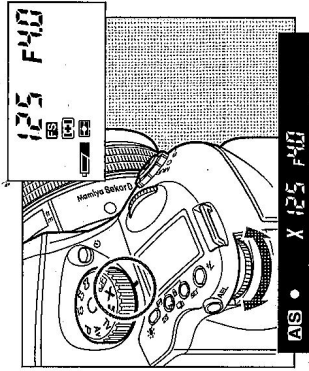

Select this mode when you use a flash. The shutter speed will be fixed at 1/125 second for synchronization. To adjust synchro speed, turn the rear dial.

- ★ When you take a photograph with TTL light metering with a Meiz flash, see pages 70 to 74.
- ★ For flash photography, see pages 70 to 75.
- ★ When using a large flash unit for use in studios, changing the synchronizing speed is recommended. (page 75)
- ★ When 1/800 sec. shutter speeds can not be achieved even though the leaf shutter lens is attached, try another exposure mode.



The selected aperture value can be locked. → See page 68

### CF (Custom Function) Mode

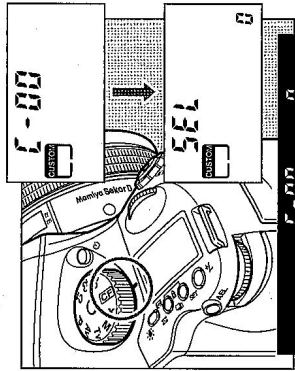

You can change the camera functions and methods for using the camera using custom functions.

- ★ For details of custom functions, see pages 76 to 82.

### C1, C2 or C3 Modes

Mode dial options "C1", "C2" and "C3" can be used to memorize preferred settings. These settings can be changed instantly to suit the photographer's needs. Programmable settings are exposure mode, "P" (program AE), "Av" (aperture priority AE), "Tv" (shutter speed priority AE), "X" (synchro mode), "M" (manual mode), focus area and spot metering.

### Programming C1, C2 or C3

1. Go to the setting you wish to assign to "C1", "C2" or "C3".
2. To record this setting, hold the set button down for one second until the details are displayed, then press the SET button while turning the mode dial to "C1", "C2" or "C3". When you release the SET button, the chosen setting will be programmed to your selection of "C1", "C2" or "C3".

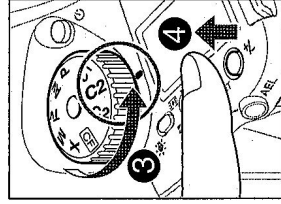
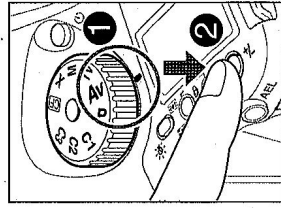

\* The illustration shows the exposure mode "Av" (aperture priority AE) being recorded to C2.

- ★ Even when the power is switched off, the mode recorded will still be saved to C mode.
- ★ "C1", "C2" or "C3" modes can be changed while photographing. However after taking a photo in a mode other than the modes selected in "C1", "C2" or "C3", when you turn the dial back to a C mode setting the change will not be saved.

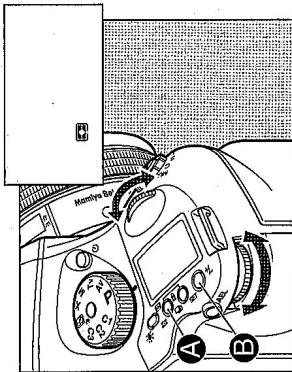

There are three exposure metering mode to select a proper exposure modes appropriate to the lighting condition of subject.

## How to select an exposure mode



1. Exposure mode mark is displayed when the exposure mode button **A** is pressed. Since three different exposure modes are displayed sequentially when either the front or rear dial is turned, select an appropriate exposure mode.
2. Press the SET button **B** or exposure metering mode button **A** to enter the setting.

## Exposure Metering Modes

 <p>Average/spot auto exposure metering</p>	<p>Exposure metering is performed after automatically selecting average/spot exposure metering</p> <ul style="list-style-type: none"> <li>• Depending on the subject conditions, center-weighted average/spot exposure metering is selected automatically, and the correct exposure is measured</li> <li>• Spot exposure metering is automatically selected when the brightness of the spot exposure metering range becomes darker than the brightness of the entire screen.</li> <li>• If there is very little difference between the spot exposure metering value and center-weighted average exposure metering value, the correct exposure level is obtained as the intermediate value.</li> </ul>
 <p>Center-weighted average/spot exposure metering</p>	<p>The average brightness of the entire screen is measured, emphasizing the center of the screen.</p>
 <p>Center spot exposure metering</p>	<p>The brightness of an area equivalent to 7.6% at screen center is measured, and the exposure is determined. The circle at screen center serves as a general guideline. This mode is suited to measuring subjects with strong contrasts or measuring only screen portions.</p>





## Important

- When a polarizing filter is used, ensure that a circular polarizing filter (circular filter: C-PL) is used. The correct exposure cannot be obtained with a normal polarizing filter (PL).

## Exposure warnings

With an inappropriate exposure setting, when shooting subjects that are too light or dark, the user is warned by the flashing external LCD or the LCD inside the viewfinder. At such times, the correct exposure cannot be obtained.

### Warnings that the exposure is outside the metering range

- Program AE (P) -----  
The shutter speed and f-number blink. 
- Aperture priority AE (Av) -----  
The shutter speed blinks. 
- Shutter priority AE (Tv) -----  
The f-number blinks. 
- Manual mode (M) -----  
The exposure metering value difference is displayed. 



The time used for the metering function can be changed.  
 Custom settings (C-03 on page 80)

# Exposure Compensation

In some situations, such as a great difference between the subject and background brightness or overall subject tones that will not meter correctly because they are all black or white, the resulting photograph may be under- or overexposed. When this occurs, use the exposure compensation function. Exposure compensation can also be used when you want to intentionally create overexposed or underexposed pictures.

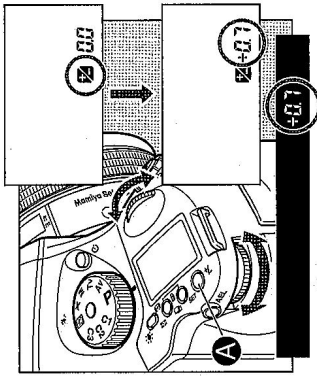

1. When exposure compensation button **A** is pressed, **Z** appears on the external LCD. When the front or rear dial is turned counterclockwise, the exposure is increased; conversely, when it is turned clockwise, it is decreased. The exposure compensation value can be checked on the external LCD or LCD inside the viewfinder.

2. After taking the pictures, press exposure compensation button **A** again to return the exposure compensation value to 0.

The exposure compensation value mark on the external LCD is cleared, and the exposure compensation function is released.

- ★ Exposure compensation is also possible during AE lock.
- ★ The shutter speed changes with exposure compensation in manual mode ("M").

## Display of the exposure compensation of the viewfinder LCD

(When a Metz flash is not equipped.)

Exposure mode	Exposure compensation display
P Program AE	The set value is displayed.
Av Aperture priority AE	The set value is displayed.
Tv Shutter priority AE	The difference between the metered value and the set exposure value is displayed.
M Manual mode	Not displayed.
X Synchro mode	Not displayed.



The width of the exposure compensation step can be changed.  
 ↑ Custom settings (C-01 on page 80).

## AE Lock Mode

Shooting with the AE lock function is useful in cases where the desired focal point differs from where the focal point is usually measured, or when it is necessary to measure the exposure using spot metering in order to bring the desired subject into focus.

The AEL button will lock the Auto-exposure value as the photo is being recomposed.

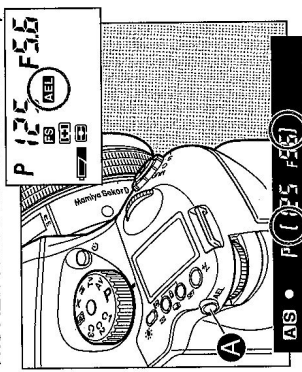

1. Turn the exposure mode setting dial and select "P", "Av" or "T".

2. Focus on the subject for metering exposure, and press the AEL button (A) on the rear of the grip. [ ] will appear on the viewfinder LCD, indicating that the exposure value is locked.

3. Move the camera to recompose the shot, then take the picture.

4. By pressing the AEL button (A), AE lock will be cancelled.

★ [ ] on the viewfinder LCD blinks to indicate the exposure is locked, when you continue to take the next picture in the AE lock mode.

★ If you turn the shutter release mode selector lever to the "L" (power OFF) position, or after a lapse of one hour, the AE lock mode will automatically be cancelled.

★ In the Manual "M" exposure mode, you cannot use the AE lock function.

★ When the exposure metering value difference display appears, press AEL button (A) for about 1 second. The one-push shift function is now activated to shift to the shutter speed based on the metered result. (page 47)

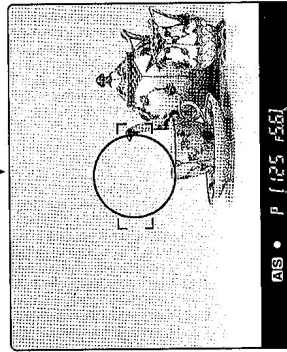
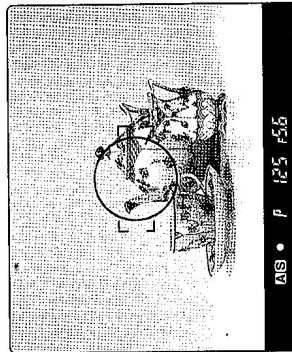

## Metered-value difference indicator

Keep pressing the AEL button (A), and the difference between the metered exposure value and the exposure of the new composition will be displayed on the viewfinder LCD. This function can be used to see if an object of very different brightness levels can be properly captured.

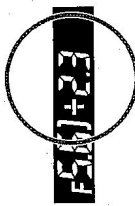
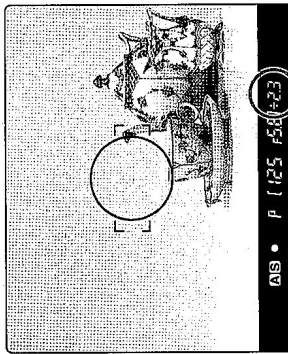

★ If the difference between the set value and the metered value exceeds 6EV, the viewfinder LCD blinks "–U–" for underexposure and "–O–" for overexposure.

By turning the front or rear dial in the AE lock mode, you can change the aperture and shutter speed value without changing the exposure value that is set when entered into AE lock mode.

In the "P" mode (Program AE) mode, turning either the front or rear dial shifts the program to "PH" and "PL." When in "Av" (Aperture priority AE) or "Tv" (Shutter priority AE), turning one of the dials changes both the aperture and shutter speed values.

★ Exposure compensation and auto bracketing function can be used when the camera is in the AE lock mode in normal operation or with the mirror locked up.



1. The way to cancel the AE lock can be changed.
  - ➔ Custom settings (C-11 on page 81)
2. Half-pressing of the shutter release button can activate the AE lock mode.
  - ➔ Custom settings (C-10 on page 81)
3. The assignment of the AEL button and AFL button can be swapped.
  - ➔ Custom settings (C-09 on page 81)

## Auto Bracketing Mode

When in situations where it is difficult to determine the best exposure compensation, it is advisable to change the exposure setting gradually (from normal to under and over).

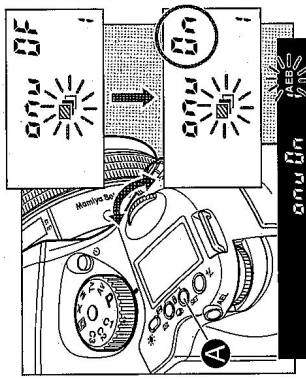

1. Turn the shutter release mode selector lever to the "S" or "C" position.  
When set at the "S" position, you can shoot one frame with each press of the shutter release button. In the "C" mode, the camera takes three (or two) frames successively with one press of the shutter release button.
2. By pressing the auto bracketing button, auto bracketing mode is selected.  
In the main LCD, the auto bracketing mark will flash on and off. As it is flashing, turn the front dial to "On".

3. Press the shutter button, and take the pictures.

When the shutter button is pressed during shooting in auto bracketing mode, the shooting sequence and auto bracketing mark blink on the LCD inside the viewfinder. Furthermore, the auto bracketing mark blinks, the bracket step width is displayed, and the shooting sequence can be checked on the external LCD.

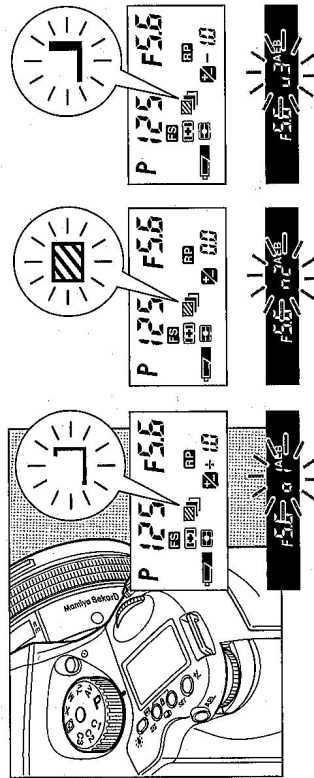

## Single-Frame Mode (S)

Press the shutter release button for each shot.

The camera meters adequate exposure value for each shot and performs auto bracketing. The camera stays in the auto bracketing mode until the last shot has been taken or you cancel the auto bracketing mode manually.

## Continuous Mode (C)

By pressing the shutter release button once, the camera takes 3 (or 2) shots in series. With each press of the shutter release button, the camera repeats auto bracketing. The standard (normal) exposure value will be fixed when you take the first image.

★ When the number of images recorded for auto bracketing photography is less than 3 (or 2) in the auto bracketing mode, the "— no —" mark blinks and the camera automatically cancels the auto bracketing mode.



1. The width of the bracket can be changed.  
→ Custom settings (C-01 on page 80)
2. The number of frames bracketed can be changed.  
→ Custom settings (C-05 on page 80)

3. When exposure compensation is initiated by pressing the exposure compensation button, shooting in auto bracketing mode is possible using the exposure value to which the exposure compensation value has been added.

## AE settings under auto bracketing mode

	Exposure mode	Setting
P	Program AE	Shutter speed varies
Av	Aperture Priority AE	Shutter speed varies
Tv	Shutter Priority AE	Aperture varies
M	Manual mode	Shutter speed varies
X	X-sync mode	No setting

# Taking Photos with the Mirror Up

This function prevents mirror-caused vibrations which may blur the image in close-up photography, when shutter speed is slow, when a telephoto lens is used, or when photographing a poster or another picture. When using the mirror-up, Electromagnetic Cable Release RE401 (optional) is recommended.

## Using auto focus and auto exposure

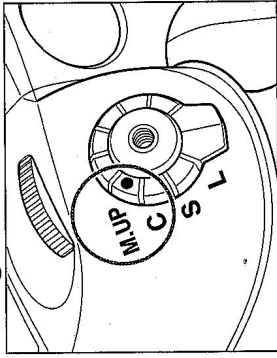

1. Set the drive dial to "M.UP."
2. Select "S" (single focus mode) by turning the focus mode selector lever.
3. Turn the exposure mode-setting dial to choose any of "P", "Av", or "TV" exposure mode.
4. Focus the subject, and determine composition and exposure.
5. The mirror moves up when the shutter button is fully pressed.
6. Press the shutter button again to take pictures.

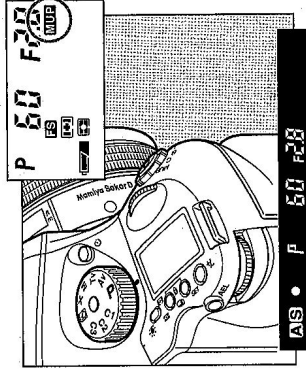

- ★ Auto bracket exposures can be made when the auto bracketing mode is set before taking photos with mirror up.
- ★ After the set time, mirror up photography will be cancelled.
- ★ The mirror will return to the original position if the lens is removed from the camera body.



Mirror up exposure time can be adjusted.  
→ Custom settings (C-03 on page 80)

## In the manual mode

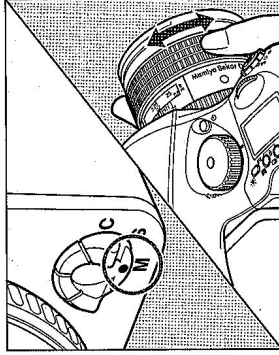

The procedure is the same as that taken up to step 3 of auto focusing.

1. Set the focus mode selector lever to "M" (manual focus mode).

2. Determine the exposure, focusing and frame structure by pressing the shutter release button halfway while looking into the view finder.

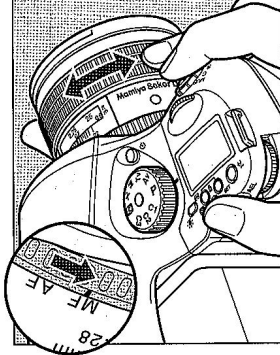

3. Mirror up by fully pressing the shutter release button.
4. Press the shutter button fully again to take the photograph.

## Caution

■ Do not point the lens at the sun during the mirror up mode. The sun's intense light can scorch and damage the shutter curtain.

## Electronic shutter release contact

For mirror-up, long exposure, or slow shutter shooting, use the magnetic cable release RE-401 or the remote control RS402 for remote shooting. The assisting release contact is to insert the cable. When in use, take the cover off from the contact and take care not to misplace the cover.

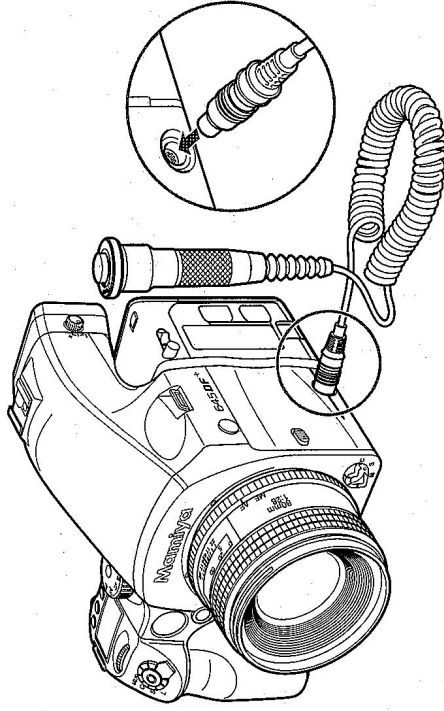

## Eyepiece Shutter

Close the eyepiece shutter when there is a strong light source behind the camera or when pressing the shutter release button without looking through the viewfinder. (This prevents exposure error due to light entering from the viewfinder.)

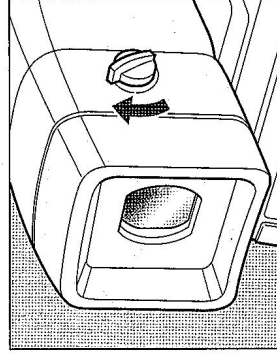

Turn the eyepiece shutter lever in the direction of the arrow.

# Taking Photos with the Mirror Up (continued)

## Mirror Up Delay

To change from the self timer setting to the mirror up setting, press the shutter button so the mirror goes into the upright position and once the set time has expired the shutter will release, and the mirror will return to the lower position. Separately purchased electronic cable release RE-401 can be used to eliminate camera shake.

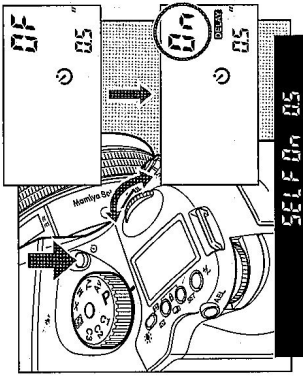

When using auto focus the operational method is the same as 1 to 3. (page 62.)

1. Press the self timer button and turn the front dial to "On"
2. Turn the rear dial to select the time needed. 0.5/ 1 seconds to 10 seconds allows for increases by the second, while 10 to 90 seconds increases by 10 seconds per turn. For 2 to 10 minutes the value increases by 10 minute and 10 to 60 minutes increases by 10 minutes per turn.
3. Line up the photograph through the viewfinder and half press the shutter button to ensure the focus and framing is correct.
4. Press the shutter button completely and the mirror will go to the upper position, then after the set time the shutter will release and the mirror will return to the lower position.

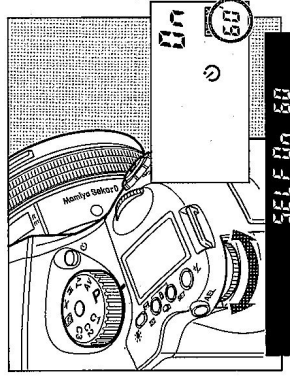

- ★ To cancel mirror up delay photography, turn to the drive dial to any setting other than "M.U.P." or turn the self timer setting off.
- ★ By turning the drive dial to the "M.U.P." setting (mirror up mode) and selecting the self timer setting, mirror up delay photography can be taken. Another method is to select self timer then turn the drive dial to "M.U.P."



## Self Timer mode

Once the shutter button has been pressed, the shutter will release after the selected time has passed. The self timer lamp will blink, and three seconds prior to when the shutter releases, the blinking will flash more rapidly. This is a useful function for the photographer to be able to take commemorative shots of his or herself.

1. Make sure the camera is firmly attached to the tripod.
2. Press the self timer button to set the self timer mode to "On".
3. Turn the front dial until self timer mode is set to "On".

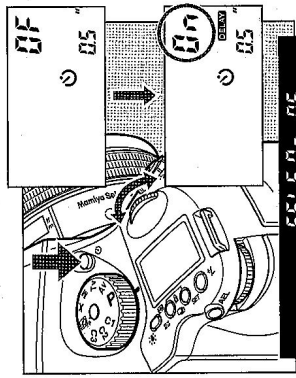

4. Turn the rear dial to select the countdown time. 0.5/1 sec. to 10 seconds is selectable by the second, 10 seconds to 90 seconds is selectable by units of 10 seconds, 2 minutes to 10 minutes is selectable by the minute while 10 to 60 minutes is selectable by units of 10 minutes.

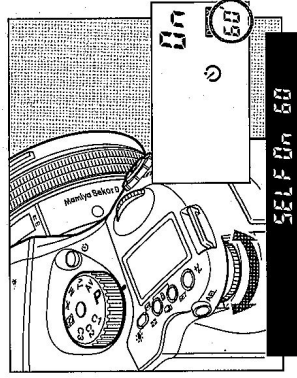

5. Check the view through the viewfinder to ensure the image area and focusing are correct then press the shutter button. The shutter will release after the selected time frame.

## Releasing self timer mode

1. Press the self-timer button to set self timer mode.
2. Turn the front dial to "Off".

★ To release the self timer while it is operating, turn off the power (by setting the drive dial to "L").

★ When there is bright light source behind the camera or when you press the shutter button without looking through the viewfinder, light may enter from the viewfinder's eyepiece, adversely affecting the exposure metering. Turn the eyepiece shutter open/close knob to close the eyepiece shutter, then take the pictures. (page 62.)

★ Mirror up delay photography can be achieved after setting self timer mode by turning the drive dial to "M.UP" (Mirror up mode). (page 61.)

## Interval Photography

By repeated turning, the interval time can be set automatically. It can be set to suit scenes such as cloud movement or views of insects in action.

1. Ensure the camera is firmly secured on a sturdy tripod.
2. Press the interval button twice for the interval mode.

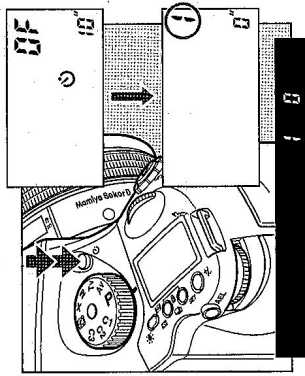

3. Turn the front dial and choose your preferred duration by turning. Settings can be made from 2 to 10 (in single units), 10 to 60 (in units of 10) or for limitless ("On").

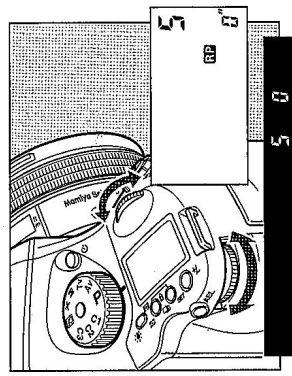

4. Turn the rear dial to set the interval time. Settings include 0 seconds (no interval time), 1 to 10 seconds (increased by the second), 10 to 90 seconds (increased in units of 10), 2 to 10 minutes (increased by the minute) or 10 to 60 minutes (increased in units of 10 minutes per turn).

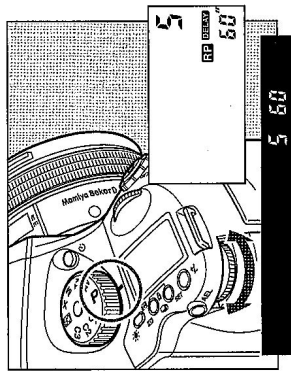

5. Check the focus and framing in the viewfinder then press the shutter for the shutter to be released.

6. Interval mode is automatically turned off when the cycle completes.

★ Repeat turning (according to the number of times) will lead to a countdown appearing in the display.

## Interval Photography (continued)

- ★ To be released from the interval photography mode while being activated, turn off the power (by setting the drive dial to "L").
- ★ When there is bright light behind the camera, when checking the framing and focus through the viewfinder and prior to pressing the shutter, ensure the eyepiece cover is closed so no unwanted light will enter the photograph.
- ★ After setting interval photography, turn the drive dial to "M.UP" (Mirror up mode) and mirror up delay photography can be taken. While photographing in the setting, "AEL" will be displayed on the main LCD. (page 61.)
- ★ When using auto bracketing, the interval function cannot be used at the same time.

## Long Exposure mode (Bulb Mode)

### Long Exposure Mode (Bulb Mode)

To expose film longer than 30 seconds, adjust the shutter speed to "B" (bulb). In order to prevent camera shake, use an electromagnetic shutter release and tripod.

1. Turn the exposure mode dial and set it to "M" (manual mode).
2. Turn the front dial to select "bulb", then turn the rear dial to set the aperture.
3. Determine the composition, focus, then take the picture. The shutter remains open as long as the shutter release button is pressed.

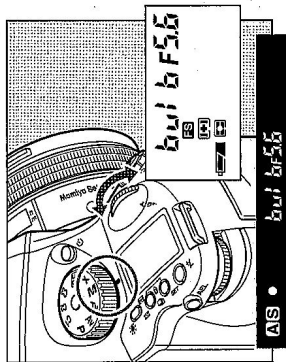

★ As the camera is electronically controlled even during exposures, it is recommended to replace batteries before bulb exposure. (See page 13.)

### Setting long exposures

When photographing under normal conditions, the shutter speed can be adjusted for longer exposures.

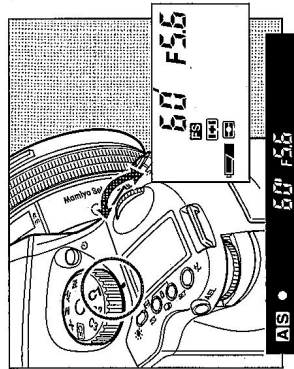

Turn the front dial for shooting time settings. New time settings include 1, bulb, TIME (Time), 2, 4, 8, 15, 30 and 60.

★ Using the "TIME" (Time) setting, the shutter will open and close according to the number of times you press it.

★ "TIME" (Time) photography is electronically controlled so it is possible that the batteries will drain quickly. In this case, please replace batteries with new ones.

## Backlight button

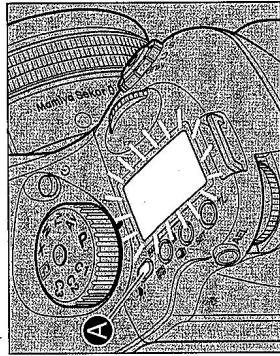

To see the main panel at night or in dark places, press the backlight button (A). The backlight will go on for approximately 20 seconds and go off unless there is another operation.

- ★ If the backlight button (A) is held down for one second, the light will remain on until the button is pressed again.
- ★ When the backlight is on, the camera will not go into sleep mode however battery power may drain quickly.

## Front / Rear Dial Lock Function

When the Electronic Dial Lock is "On," all currently set values in "Av" (Aperture Priority AE), "Tv" (Shutter Priority AE) and "M" (Manual mode) cannot be adjusted with the front or rear dials. This prevents accidental change of shutter speed or aperture values.

### How to set dial lock

Press the multiple exposure mode and auto bracketing mode button together for about 1 second so that "On" flashes on the display.

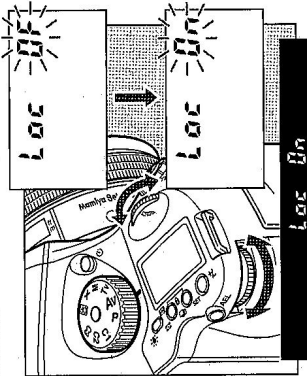

### How to release dial lock

To release dial lock, press the same buttons as in "How to set dial lock" so that "Off" flashes on the display.

- ★ The setting will be stored after one second.

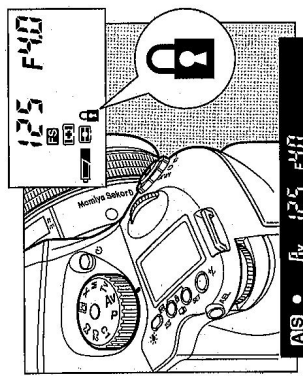

When dial lock is set, the dial lock display "B" appears on the external LCD.

- ★ When the dial lock is ON, the shutter speed and aperture will not change even if you turn the front or rear dial.
- ★ Dial lock can not be set when the exposure mode is "P" (program AE).
- ★ Even while dial lock is set, the front dial or rear dial can still be used to perform the various settings. (Dial lock is temporarily released.)

## Depth of Field / Depth of Field Preview

### Depth of Field

Depth of field (D.O.F.) is defined as the zone of sharpness before and behind the plane of focus. It depends on distance to subject, focal length of lens, aperture setting and distance the lens is focused at.

In addition to visual observation via the depth of field preview button, the D.O.F. can be determined by using the depth of field scale on each lens. The f/stop numbers appear on both the right and left side of the white index mark in the center of the scale. Simply read the figures which appear above the f/stop numbers on the distance scale of the lens. (see illustration below)

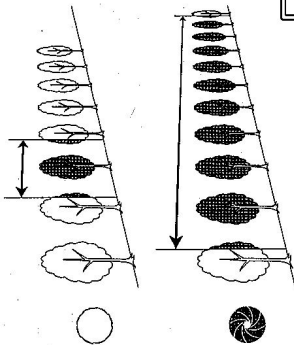

When the aperture is open  
(the subject depth is shallow)

When the aperture is  
stopped down  
(the subject depth is deep)

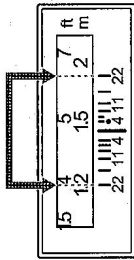

### Depth of Field Preview Button

When the preview button is pressed in, the depth of field for the aperture set on the camera can be checked by looking through the viewfinder.

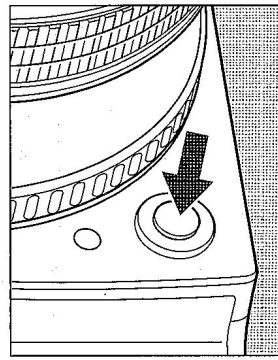

After focusing, press the preview button. The diaphragm will be stopped down to the set aperture.

★ While operating the preview button, you cannot release the shutter.

## Flash Photography

In addition to its standard flash sync system, the Mamiya 645DF features TTL (through the lens), electronic flash exposure metering. A flash sensor located inside the camera body reads the flash reflected off the sensor at the moment of exposure. The sensor is connected via the Mamiya 645DFs dedicated hot-shoe to a shoe- or handle-mount style Metz flash unit via the Metz SCA 3952 TTL Adapter. Maximum flash sync speed is 1/125 sec., making daytime synchronization possible.

To utilize the TTL flash feature with all TTL-operable Metz flash units, a Metz SCA 3952 Module is required. Please see the chart below for compatibility and/or additional adapters that may be necessary.

The resulting flash exposure automation determines correct flash exposure and automatically adjusts the output of the flash. It also automatically corrects for exposure compensation normally required when using filters, close-up bellows or extension tubes.

Metz Flash Unit	Adapter	Type of Flash	SCA3952 Module	SCA3000C Converter
Metz 44 MZ-2		Shoe-mount	X	
Metz 54 MZ-3		Shoe-mount	X	
Metz 45 CL-3 and -4		Handle-mount	X	X
Metz 60 CT-4		Handle-mount	X	X
Metz 70 MZ-5 and -4		Handle-mount	X	

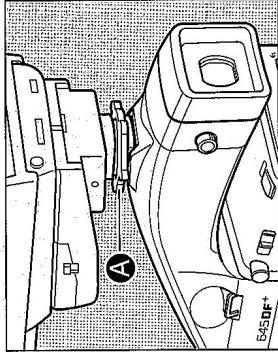

1. Mount the SCA3952 adapter onto the Metz flash, insert fully into the camera's hot shoe, then tighten with the locking knob **A**.

2. Set the exposure mode, then check the shutter speed and aperture.

Exposure mode	Shutter speed	Aperture
P Program AE	Automatically set by camera to 1/60 sec. when the metered shutter speed is 1/60 or slower, and 1/125 when it is 1/125 sec. or faster.	Automatically set by camera
AV Aperture priority AE		Any aperture
Tv Shutter priority AE	Automatically set by camera to 1/125 when the set shutter speed is 1/125 sec. or faster.	Automatically set by camera
M Manual mode		Any aperture
X Synchro mode	1/60 to 1/125 sec.	Any aperture

★ With TTL flash photography, the reflection of the flash is metered and the intensity of the flash is adjusted automatically, so TTL flash photography may not be able to suit to all conditions. In the cases described below, we recommend that you use a flash meter to check the intensity of the flash or to use a manual flash setting.

## Rear Curtain Sync Mode

For example:

- (1) When the size of the subject you want to light with the flash is relatively small within the picture
- (2) When the background behind the subject is extremely bright or when there is a strongly reflective object in the background
- (3) When the background behind the subject is extremely dark (outdoors at night, etc.)
- (4) When light from the flash is incorrectly directed and falls too widely from the subject.

## Rear Curtain Sync Mode

When a moving subject has been shot under this function, the flash of light appears after the moving subject.

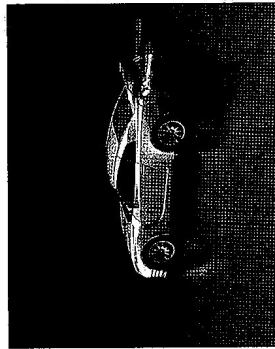

Rear curtain sync mode

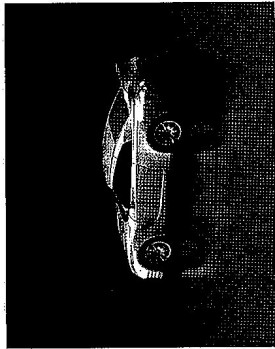

Front curtain sync mode



This function is set by Custom function setting.

→ Custom setting (C-15 on page 81)

## Metz Flash SCA3952 System Functions

Charging completed indicator in viewfinder	When charging of the flash is completed, a charging completed flash icon $\nabla$ will illuminate in the viewfinder's liquid crystal display panel.
Automatic setting of flash synchronizing speed	When exposure mode is set at "AV" or "P", the shutter speed will be automatically set to 1/60 to 1/125 sec. when charging of the flash is completed. When exposure mode is at "TV" or "M" and the shutter speed is at faster than 1/125 sec., the shutter speed will be automatically set to 1/125 sec.
Flash confirmation	The flash charge mark $\nabla$ flashes after the shutter is released to indicate that the flash was emitted properly.
Auto zoom control	The power zoom reflector is linked to the lens focal length. (Excluding the Metz 32Z-2)
Auto AF assist beam	When the focus mode is set to "S", the auto focus assist beam is emitted automatically in low light. (Excluding the Metz 32Z-2)
Display of flash range (distance)	Displayed on the flash's liquid crystal display panel. (Excluding the Metz 32MZ-3 and Metz 32Z-2)
Data transfer	Exposure compensation data and aperture data are sent from the camera to the flash.

★ When using an SCA300 system flash (Metz 60CT-4, 45CL-4, etc.), use the SCA3000C converter (sold separately).

★ For details, refer to the operating instructions of the flash and the SCA adapter.

★ To use the guide number indicated on the flash fully, wait several seconds after the charging completed indicator lights.

# Flash Compensation Settings

By combined use of a Metz flash and the SCA3952 adapter, the camera adjusts for flash. It can be adjusted within  $\pm 3EV$  in increments of 1/3 steps.

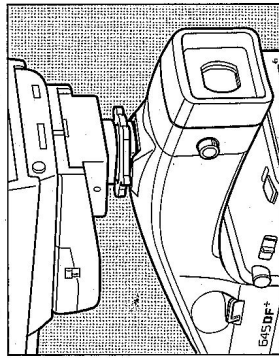

1. Turn on the power. Install the SCA3952 adapter on the Metz flash, and put it on the camera then lock the flash in place using the locking knob on the flash shoe. Turn the shutter release mode selector lever to the "S" or "C" position, and turn ON the flash power switch.

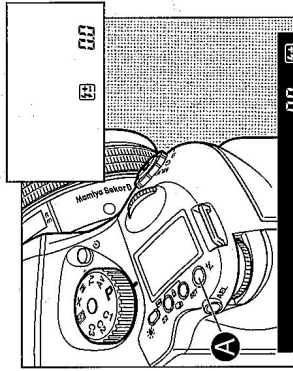

2. When the flash charge confirmation lamp lights, press the set button **A** in. The "FL" display appears on the main LCD panel.

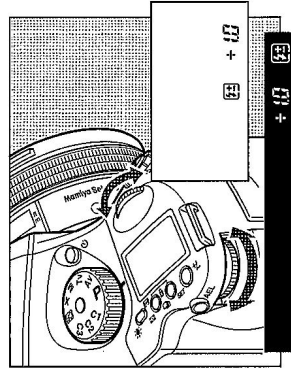

3. Turn the front or rear dial to select the flash compensation value.

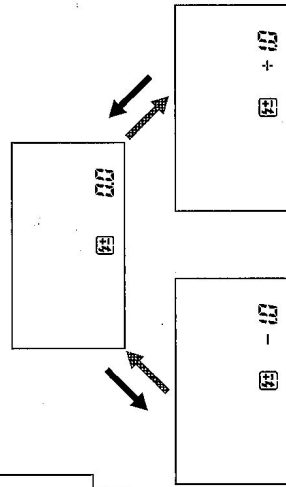

External LCD Panel (normal display)

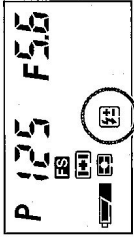

Viewfinder LCD read-outs.

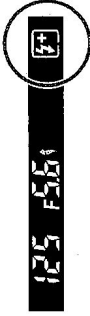

4. When the shutter button is half-pressed, the "FL" display appears on the external LCD, and "FL" appears on the LCD inside the viewfinder with a + compensation, or "FL" appears with a - compensation.

- ★ If the flash-charge mark **A** is not displayed, the flash compensation button **A** can not be used.
- ★ Keep pressing the set button to activate the flash compensation mode. You can check the exposure compensation value.
- ★ If you turn the shutter release mode selector lever to the "L" (power OFF) position, the compensation value will be canceled.

## Flash Compensation Settings (continued)

### Flash Photography with electronic flash models other than Metz

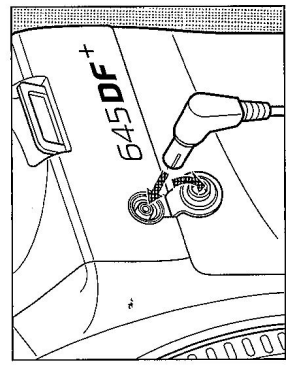

1. To use a grip type flashgun or a strobe with other electric contacts than X contact, connect the sync. cord to the camera's sync. terminal. (See note below about flashes designed exclusively for other maker's cameras.)

- ★ Remove the rubber cover when connecting the sync. cord. After shooting, be sure to reattach the rubber cover in order to protect the synchro terminal's contacts.
2. While pressing the unlock button, turn the exposure mode setting dial and set it to "X" (1/125 sec.) or "M" (manual). When "M" (manual) is selected, turn the front dial and set the shutter speed 1/60 to 1/125 sec. or slower.
  3. Turn the rear dial to set the aperture, then take the picture. (for "M", use the rear dial. For "X", use the front dial).
- ★ This camera's synchro contact is an X contact.

#### ⚠ WARNING

- Using flashes designed exclusively for other maker's cameras may damage the camera's internal mechanisms if connected to the camera's hot-shoe. In this situation, use an off-camera flash bracket and connect a sync. cord to the camera's synchro terminal.
- When using flashes with a flash duration of 1/500 sec. or longer, set the shutter speed to 1/30 sec. or less.



The selected shutter speed and aperture level can be locked.

➔ See page 68

## Custom Functions

The user can change camera functions and settings to suit personal preference.

## Setting Custom Functions

The custom functions allow you to change the method for using or accessing the camera functions as you like. Take photographs the way you are most comfortable with. The custom functions can store separate settings for 3 users. You can preset the functions for indoor, outdoor or portrait photographs and for other conditions. When at C-00, chose 1 (A), 2 (B), or 3 (C) to store a specific set of user function selections for the group of custom settings from C-01 to C-19. However, if you set C-00 to 0, the settings used will be the default set.

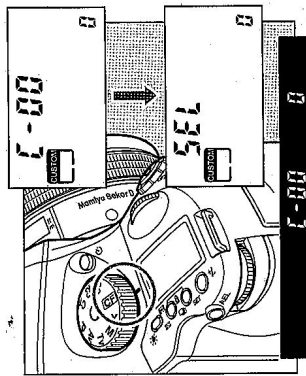

1. Turn on the power.  
Turn the shutter release mode lever to the "S" or "C" position.
2. Turn the exposure mode dial to select "CF" (Custom Function mode).

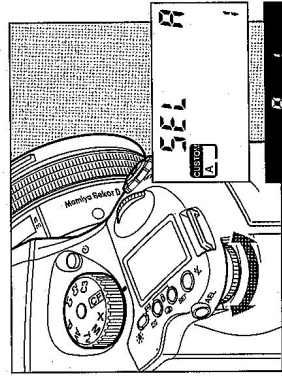

3. Turn the rear dial to select the settings for user A, B, or C.

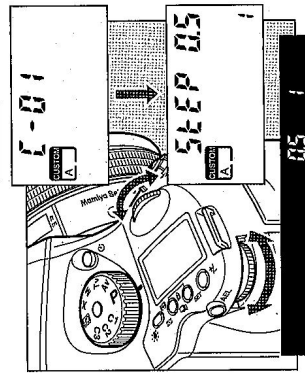

4. Turn the front dial to select the item you want to set.

★ There are 19 items from C-01 to C-19.

## Initializing User Functions

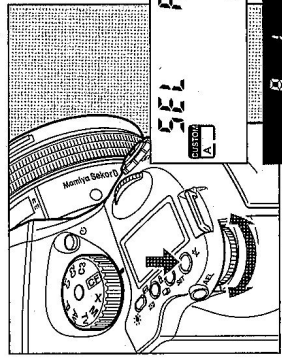

1. By turning the exposure mode dial, "CF" (custom function mode) can be selected.
2. By turning the rear dial, bank "R", "b" or "C" can be selected.
3. Press and hold down set button  (for longer than 1 second) and settings for A,B,C can be initialized, or the settings can be returned to "default".

★ The default user setting is "User 0".

★ Required to initiate at least one of the banks in order to use custom functions.

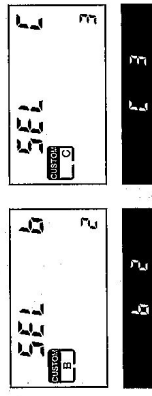



No.	Item	Initial setting (0)	1	2	3
C-00	Custom function user	Last used. Default = 0	A	B	C
C-01	EV steps	1/3	1/2	1	
C-02	Aperture after lens change	Previous value	Open	Minimum	
C-03	Time to sleep	15 sec	30 sec	60sec	ON
C-04	Battery type	ALKALINE	Ni-CD, Ni-MH	Li-ion	
C-05	Bracketing Step number	3	5	7	
C-06	Front/Rear dial exchange	Front:TV Rear:AV	Front:AV Rear:TV		
C-07	Disable rear dial in P mode	No	Yes		
C-08	Direction of Dials	No	Switched		
C-09	AEL/AFL button exchange	No	Yes		
C-10	Shutter half-press function	AF operation	AF operation & AE Lock	OFF (no function)	
C-11	AEL function	One shot	Continuous	While press	
C-12	AFL function	AF operation	No operation	Continuous	
C-13	One push M-mode	Shutter speed shift	Aperture value shift	No	
C-14	AF beam	Yes	No		
C-15	Flash sync	Front curtain	Rear curtain		
C-16	Buzzer	On(AF)	On	Off	
C-17	Shutter in Program mode (Tv, Av, P) (The leaf shutter lens is attached.)	Auto mode Within the lens shutter lens range, the lens shutter is used. Outside of this range, the focal plane shutter is used.	Leaf shutter	Focal plane	
C-18	Shutter in Manual mode (M) (In LS mode when the leaf shutter lens is attached.)	Auto mode Within the lens shutter lens range, the lens shutter is used. Outside of this range, the focal plane shutter is used.	LS mode	FS mode	
C-19	AF speed	High speed control	High accuracy control		
C-20	AF Fine Tune	50 = default Minus = move AF point closer Plus = move AF point further away			
C-97	Digital back recognition	Not ZD Back	ZD Back		
C-98	Lens FW version				
C-99	Body FW version				

**C-00 Custom functions No.**

- 0: Initial setting
- 1: A
- 2: B
- 3: C

★ When "0" has been selected and set, none of the custom items can be set. "1," "2" or "3" must be selected and set without fail.

**C-01 Steps of aperture, shutter speed, exposure compensation**

This function is used to set the shutter speed, f-number and exposure compensation value step width.  
 0: 0.3 (1/3EV step: initial setting)  
 1: 0.5 (1/2EV step)  
 2: 1.0 (1EV step)

**C-02 Aperture setting after lens change**

This function is used to set the f-number display method for the previously used lens when the lenses have been changed over. The initial setting is "Yes," in which case the f-number of the lens prior to the changeover is displayed.  
 0: Yes (previous f-number: initial setting)  
 1: Aperture open  
 2: Minimum aperture setting

**C-03 Metered value display time**

This function is used to set the time it should take for sleep mode to be established after the camera's power is turned on. The initial setting is 15 seconds. 15, 30, 60 or "On" can be selected and set.

★ Note that the batteries will continuously lose power when "On" (no sleep mode) has been set.

**C-04 Select battery**

This function is used to set the batteries used in the camera so that the remaining battery charge will be

displayed correctly on the external LCD panel.

- 0: Primary batteries (alkaline-manganese batteries, lithium batteries: initial setting)
- 1: Secondary batteries (nickel-metal hydride batteries, nickel-cadmium batteries)
- 2: Primary batteries (lithium-ion batteries)

**C-05 Auto bracketing steps**

Setting bracket's width for auto bracketing setting  
 0: 3  
 1: 5  
 2: 7

**C-06 Front/Rear dial function exchange in manual mode**

This function is used to change over the operations of the front and rear dials in the M (manual mode).  
 0: Front dial: shutter speed, rear dial: f-number (initial setting)  
 1: Front dial: f-number, rear dial: shutter speed

**C-07 Stopping the function of the P mode dial**

Initializing the P mode on the rear dial then changing the function to the front dial will cancel out P mode function on the rear dial.  
 0: No (initial setting)  
 1: Yes

**C-08 Dial function direction**

This function is used to determine the direction in which the electronic dial is to be rotated to increase and decrease shutter speed, the f-number, and exposure compensation.  
 0: No switching (CCW: decrease, CW: increase: initial setting)  
 1: Switched (CCW: increase, CW: decrease)

**C-09 AEL & AFL function button exchange**

This function is used to set whether to change over the functions of the front and rear AEL and AFL buttons.

- 0: No (front: AFL, rear: AEL: initial setting)
- 1: Yes (front AEL, rear: AFL)

**C-10 Half-press shutter release function mode**

This function is used to set the AE lock and AF operations when the shutter button is half-pressed.

- 0: AF operation (initial setting)
- 1: AF operation/AE lock
- 2: OFF (no function)

**C-11 AEL function lock/unlock mode**

This function is used to set the method of operating the AEL button to lock AE. At the initial setting (released after one shot), after AE lock is set, it is released when the shutter is tripped. At the "1" setting, when the AEL button is pressed, AE is locked; pressing the button again releases the AE lock. At the "1" setting, AE lock is set while the AE lock button is being pressed.

- 0: Released after one shot: initial setting
- 1: Continuous
- 2: While the shutter button is pressed

**C-12 AFL lock mode setting**

This function is used to set the AF lock method when the AFL button is operated.

AF Lock is activated with one press of the auto-lock button then deactivated with a second press.

- 0: Set with AF lock only (initial setting)
- 1: Set with AF lock and/AE lock
- 2: Cancelled on second press

**C-13 One push shift function**

When using M (manual mode) one push shift function, the shutter speed or aperture value can be set.

- 0: Shift shutter speed (Initialize setting)

- 1: Shift aperture value
- 2: Don't set

**C-14 AF beam setting**

The AF auxiliary light fires automatically when the subject is too dark to perform AF, but this function can be used to prevent the AF auxiliary light from firing.

- 0: Fires (initial setting)
- 1: Does not fire

**C-15 Flash sync. timing**

When a moving subject has been shot using the flash, a flash of light will appear ahead of the subject's movement under the initial setting. This function makes it possible to change this so that the flash of light comes after the moving subject as illustrated.

- 0: Front curtain synchronization (initial setting)
- 1: Rear curtain synchronization

**C-16 Beep**

When the SET button is pressed a beep sounds

- 0: ON (AF) (initialize setting)
- 1: ON
- 2: OFF

**C-17 Choose shutter function (for P,Av or Tv mode)**

When using P, Av or Tv mode and the leaf shutter lens is attached but you prefer to use the focal plane shutter.

- 0: Auto mode: Initialize setting (Fastest: 1/800sec.)
- 1: Only lens shutter
- 2: Only focal plane shutter (when leaf shutter lens is attached)

**C-18 Choose shutter function (when in M mode)**

When initializing the setting, use of the lens shutter (and its respective ranges) or the focal plane shutter can be chosen when the leaf shutter lens is attached.

- 0: Automatic switching (initialize setting)

setting)

- 1: Only lens shutter
- 2: Only focal plane shutter (when leaf shutter lens is attached)

**C-19 AF Priority**

Accuracy of speed priority (initialize setting) or auto-focusing priority can be decided.

- 0: High speed control (initialize setting)
- 1: High accuracy control

**C-20 AF Fine Tune**

This function is used to fine-tune the focus point on subject closer or further away from the camera.

- 50: default
- Minus: move AF point closer
- Plus: move AF point further away

**C-97 Digital back recognition**

- 0: Not ZD Back
- 1: ZD Back

**C-98 Lens firmware version**

The current firmware version can be checked.

**C-99 Body firmware version**

The current firmware version of the body can be checked.



**Miscellaneous  
Operations**

## Changing the Focusing Screen

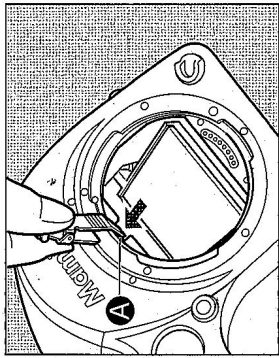

1. Switch the dial drive to "L" to turn off the camera's power and remove the lens.
2. Pull the focusing screen release lever **A** forward, as illustrated, with the tweezers to let the focusing screen down.

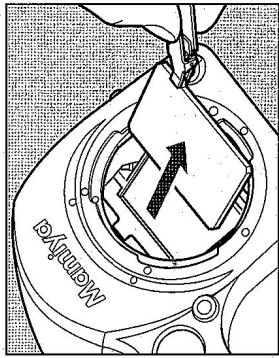

3. Remove the focusing screen from the focusing screen frame by grasping the tab on the edge of the screen with tweezers as illustrated.

★ Do not touch and damage the mirror in any way.

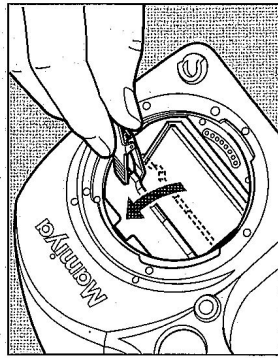

4. When installing the screen, pinch the tab of the screen with tweezers, and put the screen on the screen frame.

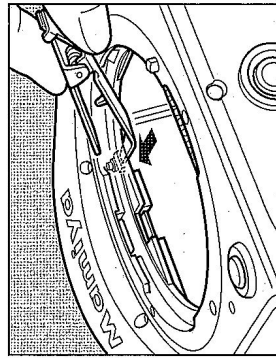

5. Push up the screen frame using the tweezers until hearing a clicking sound. The screen is now properly installed.

★ Never press down on other parts as this will affect the focus function.

## Caution

- ★ Since the focusing screens' surfaces are soft and easily damaged, handle them carefully.
- ★ Never touch the surface with bare fingers. Should dust settle on it, merely blow away by using a blower.
- ★ If the focusing screen needs cleaning, send it to the nearest authorized Mamiya service center. Do not attempt to clean the surface of the focusing screen, as it is very delicate.

## Using the M645 Manual Focus Lenses

When using the MAMIYA M645 manual focus lens, mount the focusing screen for manual focus lenses (sold separately).

1. Mount the M645 lens on the camera body, turn the A/M lever on the lens to the "M" position. Set the lens to maximum aperture, compose and focus. You may use the focus mark to adjust focus.

2. Select exposure mode and set the desired aperture on the lens.

★ For auto exposure, select the "Av" (aperture priority AE) and choose the spot exposure metering mode "S", you can use the lens in conjunction with stop-down metering.

3. Half press the shutter release button to show shutter speed.

### Available functions with M645 lens

	P	Av	Tv	M	X
Exposure mode	X	○	X	○	○
Metering mode	X	○	X	○	X
Exposure compensation	X	○	X	○	X
Auto-bracketing mode	X	○	X	○	X

X = not an available function  
○ = available function

★ You can adjust focus with assistance of the focus mark in the viewfinder LCD. When stopping down slower than f/5.6, the focus mark will be unworkable. In this case, the out of focus direction marks ► ◀ will blink and show that the picture is out of the focus adjustment range.

★ The AF assist beam does not emit with these lenses.

## External Battery Socket

When using the camera at cold temperatures where the battery capacity may drop, use an external battery case PE401 (sold separately; PE401).

1. Turn the shutter release mode selector lever to the "L" position (power OFF).

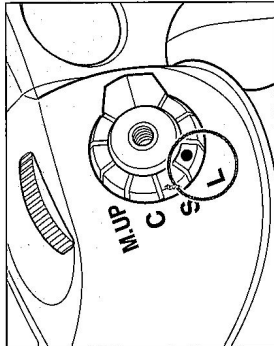

2. Use a coin or similar object to turn and remove the external battery socket cap.

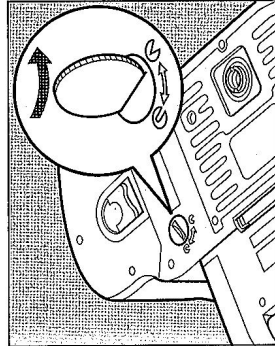

3. Remove the battery case from the camera body.

4. Connect the external battery case to the body.

Connect the plug of the external battery case in which the batteries are installed, to the external battery socket.

5. Reinstall the original battery case, from which the batteries were removed, in the body. Turn the battery case lock lever to lock it in the body.

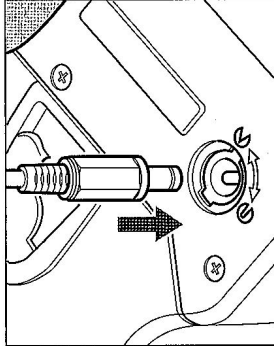

★ Make sure to reinstall the empty battery case into the body.

■ The empty battery cassette must be inserted into the body.

The batteries may generate heat if the external battery case is connected to the body while the batteries are loaded on the body.

## Using a Tripod

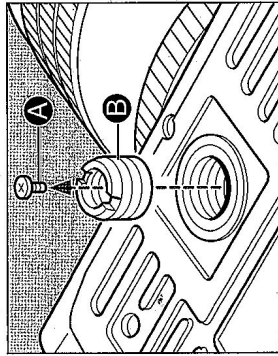

When using a tripod with 3/8" screw (instead of 1/4" screw) remove the small screw **A** from the tripod screw hole on the bottom of the body using a plus screwdriver, then use a coin to remove the tripod screw adapter bushing **B**.

# When You Think Something Might Be "Faulty"

In the conditions below or when the LCDs display the items listed in pages 91 and 92, they are not necessarily faults. Check the camera referring the descriptions below.

### - Unable to release the shutter

Check to see if the batteries are installed. Check to see if the batteries are dead. Check to see if the power is on (the shutter release selector lever should be set to "S" or "C" position).

### - The viewfinder does not show LCD read-outs.

Check to see if the batteries are installed. Check to see if the batteries are dead. Check to see if the power is on (the shutter release selector lever is other than in the "L" position).

Check to see if the digital back is installed.

If the camera has not operated for longer than 15 seconds, the viewfinder LCD readouts will automatically disappear.

This camera employs a microcomputer. It is possible that the camera may malfunction when exposed to static electricity or the like. In this case, turn OFF the camera power and then remove the batteries. Reinstall the batteries, then turn the power on. If the camera does not function properly after these steps, contact our sales office or service center.

# When Any of These Displays Appear

LCD display		Problems	Causes and remedies	Ref. page
Main LCD panel	Viewfinder / LCD read-outs / Magazine LCD			
batt	▶ ◀	<ul style="list-style-type: none"> <li>If the camera cannot focus in the AF-S (Single) mode, you cannot release the shutter.</li> <li>When an M645 lens is installed, and the aperture is less than f/5.6, this indicator appears.</li> <li>This indicator appears when the battery capacity is low.</li> </ul>	<ul style="list-style-type: none"> <li>Try to adjust focus again, or change to the focus lock mode or manual focus mode.</li> <li>Make the lens aperture faster than f/5.6.</li> </ul>	28 36
-no- db	batt	<ul style="list-style-type: none"> <li>The shutter will not operate when the digital back is not installed onto the camera body. If you try to press the shutter, this indicator appears.</li> </ul>	<ul style="list-style-type: none"> <li>Replace with new batteries.</li> <li>Install the digital back onto the camera body.</li> </ul>	14
F	-no- db	<ul style="list-style-type: none"> <li>This symbol appears when setting the custom functions but you have not selected user A, B, or C.</li> </ul>	<ul style="list-style-type: none"> <li>Select a user before changing the custom function settings.</li> </ul>	25
	- U - - 0 -	<ul style="list-style-type: none"> <li>While in manual exposure mode, and when the difference between the set value and metered value exceeds 6EV, this indicator will appear.</li> </ul>	<ul style="list-style-type: none"> <li>Change aperture or shutter speed.</li> </ul>	78
	F	<ul style="list-style-type: none"> <li>This will appear when a lens is not installed.</li> <li>When an M645 lens is installed.</li> </ul>	<ul style="list-style-type: none"> <li>Install a lens on the camera body.</li> </ul>	46, 52, 56
Err 01 Err 02 Err 03 Err 04 Err 05 Err 06 Err 07	Err 01 Err 02 Err 03 Err 04 Err 05 Err 06 Err 07	<p>When "Err" appears, some abnormality has been detected in the course of taking photos.</p>	<ul style="list-style-type: none"> <li>Replace with new batteries and press the shutter release button. If the "Err" indicator still does not disappear, then contact our sales office or service center.</li> </ul>	87 96

★ The camera caution mark  will blink if the camera body detects an abnormality.

# Specifications

- Camera type : 6x4.5cm format, electronically controlled focal-plane shutter, TTL multiple mode AE, AF single lens reflex
- Actual Image size : 56x41.5 mm
- Lens mount : Mamiya 645 AF Mount, compatible with M645 Mount (manual focus confirmation, focus aid, stopped-down exposure metering)
- Viewfinder : Fixed prism viewfinder magnification x0.71; built-in diopter adjustment (-2.5 to +0.5, optional diopter correction lenses provide adjustment ranges of -5 to -2 diopter and 0 to +3 diopter); built-in eye-piece shutter
- Focusing screen : Interchangeable, Matte (standard), Checker, and Microprism Type C for Non-AF M645 lenses.
- Field of view : 94%\* of actual image
- Viewfinder information : Focus mark, defocus mark, warning mark, aperture value, shutter speed, metering mode (A, S, A/S), exposure compensation value (difference between set value and metered value) and flash ready / OK lamp with TTL Metz connection.
- Auto focus method : TTL phase difference detection method; sensor: CCD line sensor (I+I type); operating range: EV0 to EV18 (ISO 100)
- Focus area : Displays the focus area in the viewfinder screen
- AF assist beam : Activates automatically under low light, low contrast. Range: 9m (when using AF80mm f/2.8 D lens)
- AF lock : By pressing the shutter release button halfway down in the AF-S mode, or by pressing the AFL button.
- Exposure modes : Aperture-priority AE, shutter-priority AE, programmed AE (PH, PL setting possible), and manual
- AE metering mode : TTL metering, center-weighted average (AV), spot (S), and variable ratio (A-S auto)
- Increments of shutter speed and aperture : Both the shutter speed and the aperture level can be set to 1/3 or 1/2 using the electronic dial lock function
- Metering range : EV 2 to EV 19 (with ISO100 and AF80mm f/2.8 D lens)
- Exposure compensation : Expandable to  $\pm 5$  EV
- AE lock : With AEL button; canceled by pressing the button again. When AEL button is pressed, exposure compensation and metering difference is displayed in the viewfinder. ( $\pm 6$ EV, 1/3 steps in M mode).
- Shutter : Electronically controlled vertical metal focal-plane shutter. (vertical travel)
- Shutter speed : AE 30 to 1/4000 sec. (1/8 step), manual 30 to 1/4000 sec. (1/2 or 1/3 steps), 1 min-60 sec. (1 step), X, bulb (Bulb, electronically controlled), TIME, shutter curtain protection mechanism

- Auto bracket shot : Enable with auto bracket button (3 frame shots, 5 frame or 7 frame shot with auto bracketing). Specify 1/3, 1/2, 2/3 or 1EV steps.
- Flash synchronization : X contact point, 1/125 seconds. Synchro speed can be changed away from terminal.
- Flash control : TTL direct flash control, supports Metz SCA3002 system (SCA3952 Adapter)
- Mirror up shot : Select by pressing the mirror up button.
- LCD displays : Program AE mode icon, synchro mode icon, shutter speed, aperture, custom function icon, user function icon, focal plane mode icon, lens shutter mode icon, AE lock icon, auto focus lock icon, mirror up icon, focus area icon, auto bracketing icon, self timer icon, repeat mode icon, delay mode icon, remaining battery power icon, spot metering icon, dial lock icon, flash compensation icon, exposure compensation icon, exposure compensation, delay time.
- Sync terminal : X contact (sync speed 1/125 sec.)
- Cable release socket : On shutter button
- Remote-control terminal : On side of body; electromagnetic cable release RE401 and RS402 can be purchased separately.
- Self timer : Self timer intervals can be set from 0.5 to 90 sec.: 0.5-10 sec. by the second, 10 to 90 sec. in 10 sec. units, 2 to 10 mins by the minute and 10 to 6 mins in units of 10 minutes.
- Depth-of-field confirmation : Preview Button on body
- Custom settings : 20 items
- Tripod socket : U 1/4 inch and U 3/8 included
- Power requirements : 6 AA-size batteries (alkaline-magnesium, lithium, nickel-hydrate or nickel-cadmium rechargeable batteries).
- External power socket : An external battery case can be connected.
- Size & weight : 6"(W)X5"(H)X6"(D) / 153(W)X128(H)X152(D)mm : 2.3 pounds / 1,030 g (body only)

\* This information is based on a linear (horizontal/vertical) measurement.



## Maintenance and care of the camera

- Read instructions before using camera.
- Protect camera against shocks and falls. Use the neck strap supplied with it, whenever possible.
- Check the batteries frequently and always carry spares. The sealed batteries supplied with the camera may have been subject to storage conditions which have reduced its service life.
- Be sure to wipe battery contacts before installation and watch correct polarity.
- Battery life differs, depending on frequency of use, type, age, storage condition, ambient temperature (use external battery case in very cold weather), etc.
- Always remove the battery when camera is not used for a long period of time.
- Always keep covers on lenses and camera body.
- Do not store the camera at temperatures exceeding 40°C (105°F) and -10°C (15°F). Also avoid humid or sea air environment.
- Prolonged disuse shortens camera life. Periodically exercise the shutter (at different speeds), lens diaphragms (at different apertures) and focusing mechanism.
- Protect camera against rain and moisture.
- Do not touch lens surfaces. Use blower or lens tissue to remove dust particles.
- Always test your equipment before going on important assignments.

## The Importance of Proper Maintenance

Your camera has mechanisms like shutters and diaphragm blades. They are controlled by gears, levers, springs, and so on. All require special lubrication from time to time. Ambient conditions can also affect these mechanisms, as well as the electronic components and the optical glass of your lenses. We therefore suggest that you have your camera and lenses checked, and if necessary serviced, periodically.

## After-Sale Servicing

☆ Be sure to read the terms and conditions in the warranty card.

1. For inquiries, opinions or questions concerning the product, please contact your nearest Mamiya agent or service center.
  2. Servicing after the expiration of the period specified in the warranty card will be charged to the user. The freight and transport costs should always be paid by the user.
  3. The servicing parts for use in repair of the product will be retained at the factory for ten years from the date of discontinuation of production.
- ◎ Servicing is available for the same period as the servicing part retention period. As the product may be serviceable even after this period, please consult your dealer or nearest Mamiya service center for its serviceability.
- ☆ Servicing of malfunction or damage due to dropping, impact, fire, flood, etc.
- 1) The degree of such a malfunction or damage will be judged by the Mamiya service department.
  - 2) Such a malfunction or damage will be classified either non-serviceable or serviceable. When the product is classified to be serviceable, it will be repaired at the expense of the user, even if the malfunction or damage occurred within the warranty period.

**Mamiya**

**Mamiya Digital Imaging Co., Ltd.**



英語

Printed in Japan  
320300-LJ-04E